

## COOPER

Design Gianfranco Frigerio

**Struttura:** legno multistrato imbottito in poliuretano espanso indeformabile rivestito con trapuntino in piuma d'oca (Assopiuma).

**Bracciolo:** legno multistrato imbottito in poliuretano espanso indeformabile rivestito con trapuntino in piuma d'oca (Assopiuma), è un pezzo unico con la struttura del divano, non è removibile.

**Seduta:** poliuretano espanso indeformabile rivestito con trapuntino in piuma d'oca (Assopiuma).

**Cuscini schienale:** piuma d'oca (Assopiuma).

**Piedini:** neri.

**Rivestimento:** sfoderabile in tessuto, fisso in pelle.

**VERSIONE COOPER MEDIUM:** profondità 101cm

**VERSIONE COOPER LARGE:** profondità 113cm

**VERSIONE COOPER JUNIOR:** profondità 92cm, gli elementi di questa versione sono accostabili solo fra di loro e non con gli altri elementi della collezione Cooper.

### ACCESSORI:

| **cuscini decorativi:** in dimensioni specifiche in piuma d'oca

| **elemento angolare:** realizzabile nella versione MEDIUM con il bracciolo MSH; realizzabile nella versione LARGE con il bracciolo LSH.

| **pouf:** collezione di pouf coordinati in differenti misure.

**Structure:** plywood padded with non-deformable polyurethane foam covered with quilt in goose down (Assopiuma).

**Armrest:** plywood padded with non-deformable polyurethane foam covered with quilt in goose down (Assopiuma) and it is one piece with the sofa structure, it cannot be removed.

**Seat:** non-deformable polyurethane foam covered with quilt in goose down (Assopiuma).

**Back cushions:** goose down (Assopiuma).

**Feet:** black.

**Cover:** removable in fabric, fix in leather.

**VERSION COOPER MEDIUM:** depth 101cm

**VERSION COOPER LARGE:** depth 113cm

**VERSION COOPER JUNIOR:** depth 92cm, the elements of this version could be used only between each other and not with the other elements of the Cooper Collection.

### ACCESSORIES:

| **beauty cushions:** in specific sizes in goose down

| **corner element:** composed in the MEDIUM version with armrest MSH; composed in the LARGE version with the armrest LSH.

| **pouf:** collection of coordinated poufs in different sizes.



## COOPER MEDIUM Design Gianfranco Frigerio

### BRACCIOLI / ARMRESTS

#### cod. 10400 - MSL

Bracciolo 101x23x55 cm / Armrest 101x23x55 cm

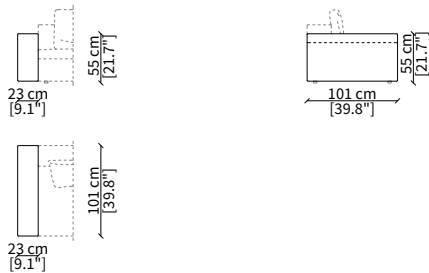

#### cod. 10401 - MBL

Bracciolo 101x41x55 cm / Armrest 101x41x55 cm

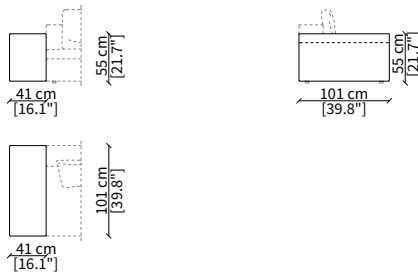

#### cod. 10402 - MSH

Bracciolo 101x23x65 cm / Armrest 101x23x65 cm

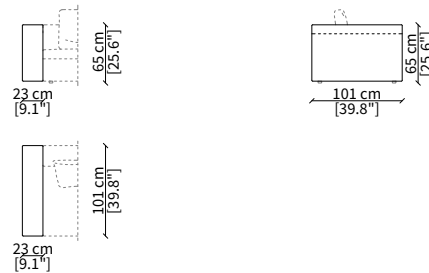

### ELEMENTI CENTRALI / CENTRAL ELEMENTS

#### cod. 10406

Elemento 78 cm / Element 78 cm

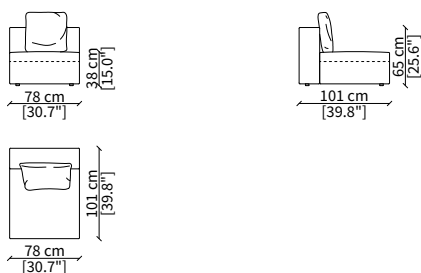

#### cod. 10407

Elemento 90 cm / Element 90 cm

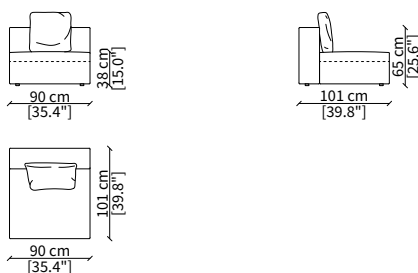

#### cod. 10408

Elemento 105 cm / Element 105 cm

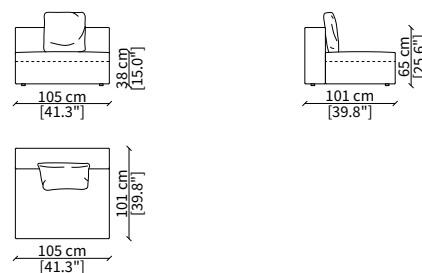

#### cod. 10409

Elemento 125 cm / Element 125 cm

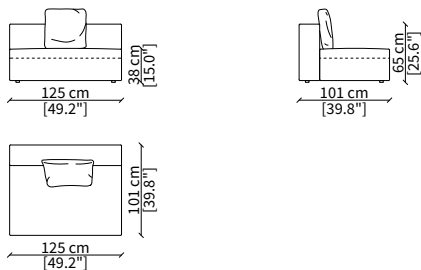

#### cod. 10410

Elemento 150 cm / Element 150 cm

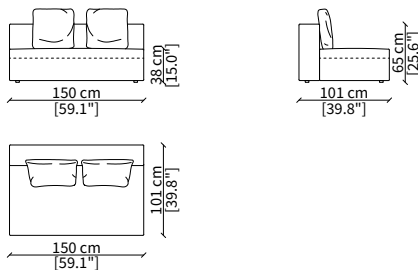

#### cod. 10411

Elemento 180 cm / Element 180 cm

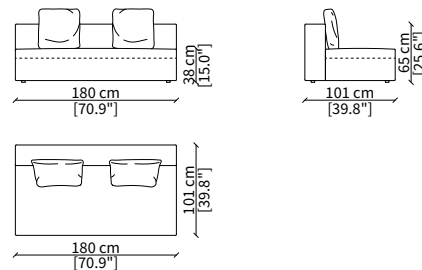

### ELEMENTI DORMEUSE / DORMEUSE ELEMENTS

#### cod. 10412

Elemento 105 cm / Element 105 cm

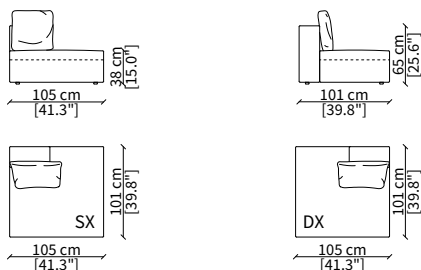

#### cod. 10413

Elemento 150 cm / Element 150 cm

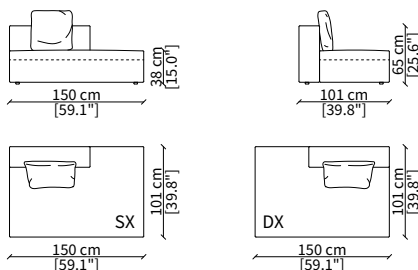

Dimensioni espresse in cm se non diversamente indicato.  
L'Azienda si riserva il diritto di apportare modifiche ai modelli senza preavviso.  
Tolleranza sulle misure indicate di +/- 2%.

Dimensions in centimeter if not differently indicated.  
The Company reserves the right to change the models without any advance notice.  
Tolerance on the given sizes +/- 2%.

## COOPER MEDIUM Design Gianfranco Frigerio

### ELEMENTO DORMEUSE LONGUE / DORMEUSE LONGUE ELEMENT

cod. 10421

Elemento 150 cm / Element 150 cm

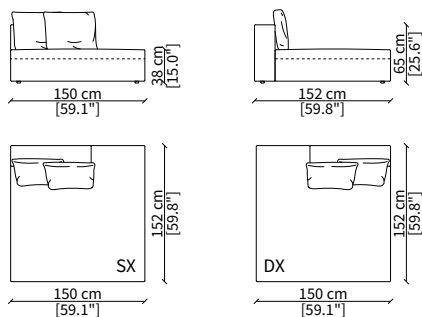

### ELEMENTO COMFORT / COMFORT ELEMENT

cod. 10419

Elemento 197 cm / Element 197 cm

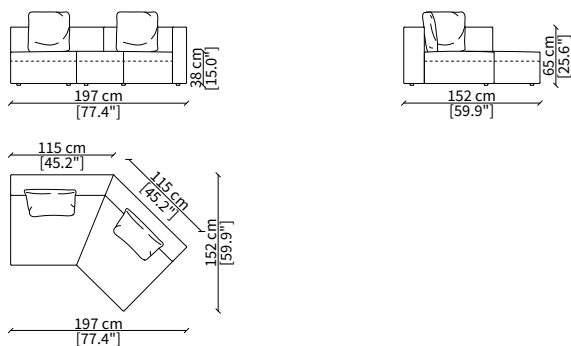

### ELEMENTO DORMEUSE COMFORT / COMFORT DORMEUSE ELEMENT

cod. 10420

Dormeuse 197 cm / Dormeuse 197 cm

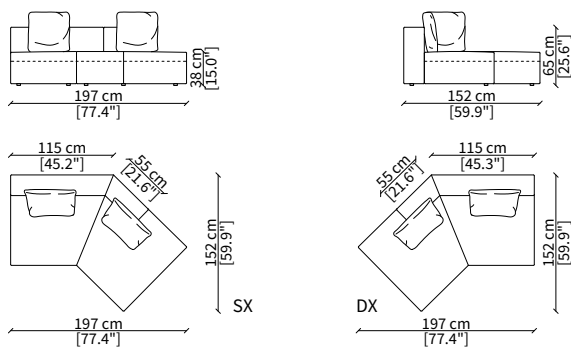

Dimensioni espresse in cm se non diversamente indicato.  
L'Azienda si riserva il diritto di apportare modifiche ai modelli senza preavviso.  
Tolleranza sulle misure indicate di +/- 2%.

Dimensions in centimeter if not differently indicated.  
The Company reserves the right to change the models without any advance notice.  
Tolerance on the given sizes +/- 2%.

## COOPER MEDIUM Design Gianfranco Frigerio

### ELEMENTI CHAISE LONGUE / CHAISE LONGUE ELEMENTS

#### cod. 10414

Elemento 90 cm / Element 90 cm

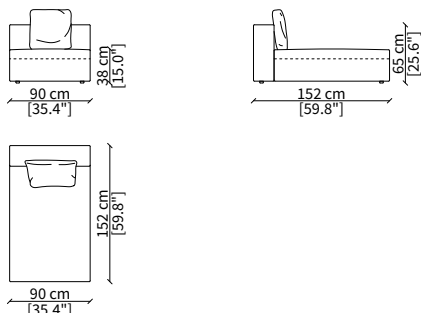

#### cod. 10415

Elemento 105 cm / Element 105 cm

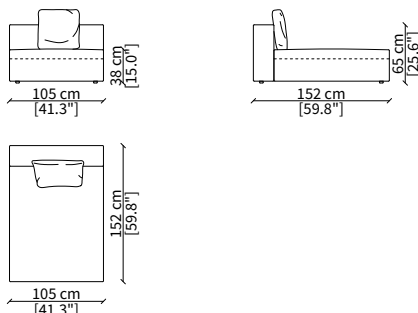

### POUFS

#### cod. 10807

Elemento 70x70 cm / Element 70x70 cm

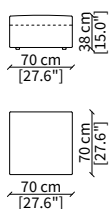

#### cod. 10416

Elemento 101x101 cm / Element 101x101 cm

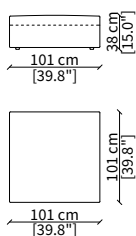

#### cod. 10417

Elemento 113x113 cm / Element 113x113 cm

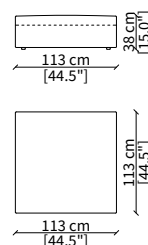

#### cod. 10422

Elemento 150x101 cm / Element 150x101 cm

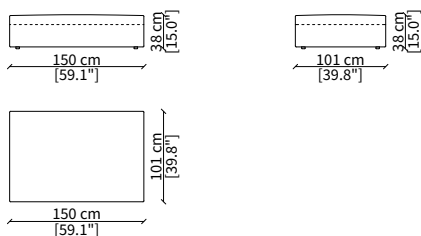

#### cod. 10423

Elemento 150x113 cm / Element 150x113 cm

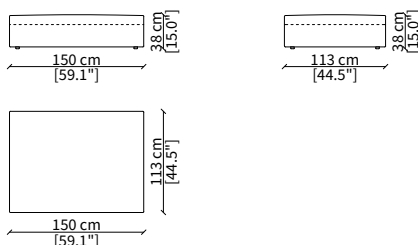

## COOPER MEDIUM Design Gianfranco Frigerio

### CUSCINI / CUSHIONS

#### cod. CO

Cuscino 58x40 cm / Cushion 58x40 cm

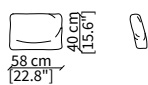

#### cod. CS

Cuscino 58x55 cm / Cushion 58x55 cm

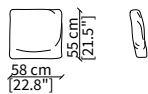

#### cod. COS

Cuscino 58x55 cm / Cushion 58x55 cm

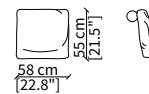

#### cod. 10424

Cuscino a libero posizionamento 57x53 cm  
Freestanding backrest 57x53 cm

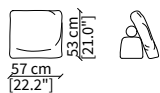

#### cod. 10425

Cuscino a libero posizionamento 78x53 cm  
Freestanding backrest 78x53 cm

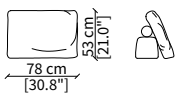

## COOPER LARGE

Design Gianfranco Frigerio

### BRACCIOLI / ARMRESTS

#### cod. 10400 - MSL

Bracciolo 101x23x55 cm / Armrest 101x23x55 cm

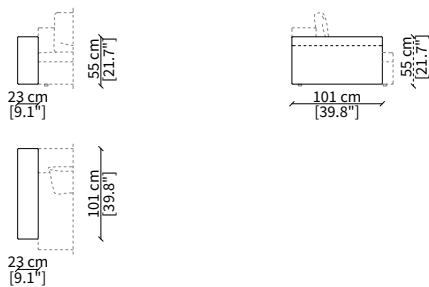

#### cod. 10401 - MBL

Bracciolo 101x41x55 cm / Armrest 101x41x55 cm

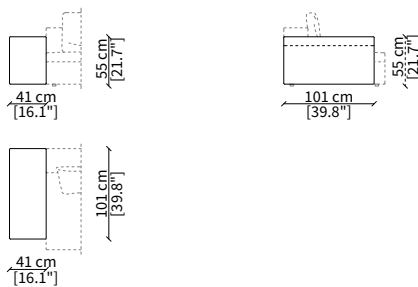

#### cod. 10402 - MSH

Bracciolo 101x23x65 cm / Armrest 101x23x65 cm

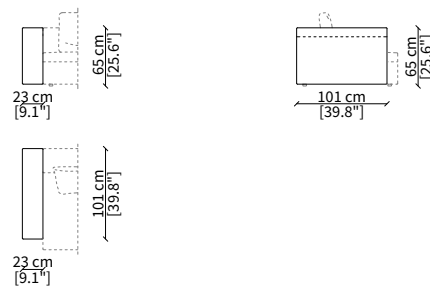

#### cod. 10403 - LSL

Bracciolo 113x23x55 cm / Armrest 113x23x55 cm

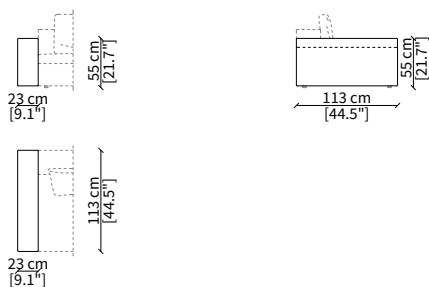

#### cod. 10404 - LBL

Bracciolo 113x41x55 cm / Armrest 113x41x55 cm

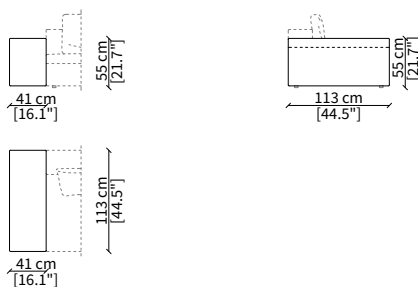

#### cod. 10405 - LSH

Bracciolo 113x23x65 cm / Armrest 113x23x65 cm

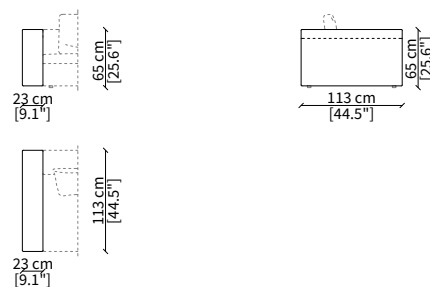

### ELEMENTI CENTRALI / CENTRAL ELEMENTS

#### cod. 10506

Elemento 78 cm / Element 78 cm

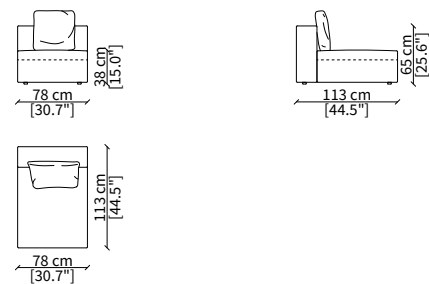

#### cod. 10507

Elemento 90 cm / Element 90 cm

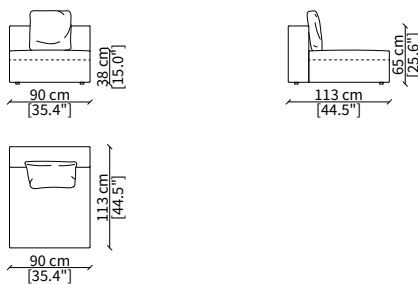

#### cod. 10508

Elemento 105 cm / Element 105 cm

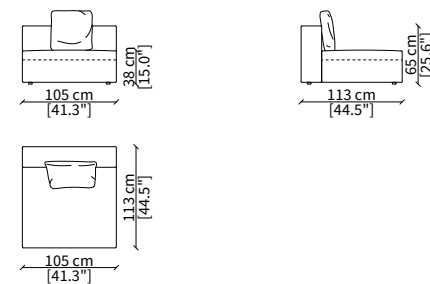

#### cod. 10509

Elemento 125 cm / Element 125 cm

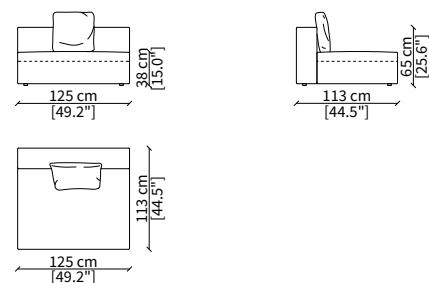

#### cod. 10510

Elemento 150 cm / Element 150 cm

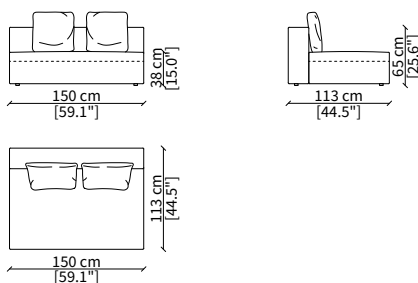

#### cod. 10511

Elemento 180 cm / Element 180 cm

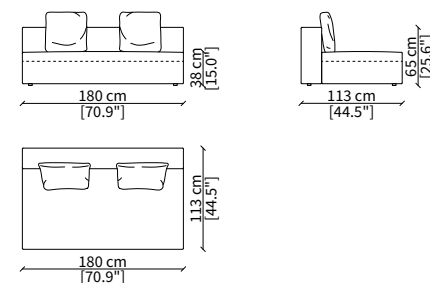

Dimensioni espresse in cm se non diversamente indicato.  
L'Azienda si riserva il diritto di apportare modifiche ai modelli senza preavviso.  
Tolleranza sulle misure indicate di +/- 2%.

Dimensions in centimeter if not differently indicated.  
The Company reserves the right to change the models without any advance notice.  
Tolerance on the given sizes +/- 2%.

## COOPER LARGE

Design Gianfranco Frigerio

### ELEMENTI DORMEUSE / DORMEUSE ELEMENTS

**cod. 10512**

Elemento 105 cm / Element 105 cm

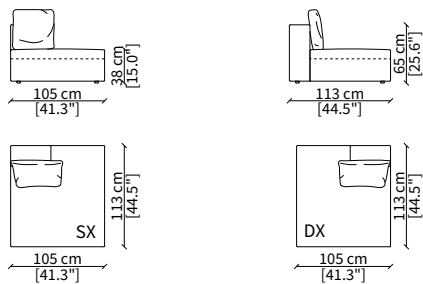

**cod. 10513**

Elemento 150 cm / Element 150 cm

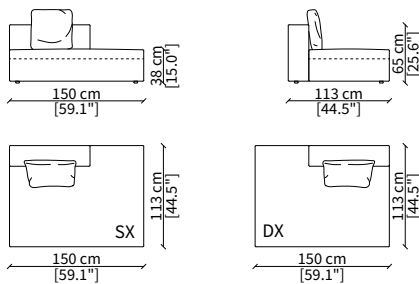

### ELEMENTO DORMEUSE LONGUE / DORMEUSE LONGUE ELEMENT

**cod. 10521**

Elemento 150 cm / Element 150 cm

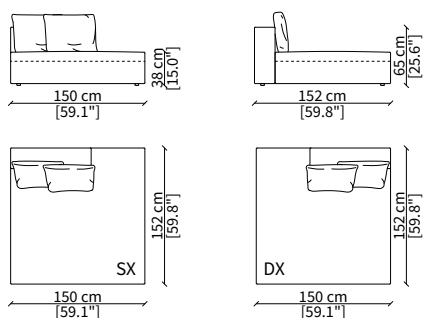

### ELEMENTO COMFORT / COMFORT ELEMENT

**cod. 10519**

Elemento 197 cm / Element 197 cm

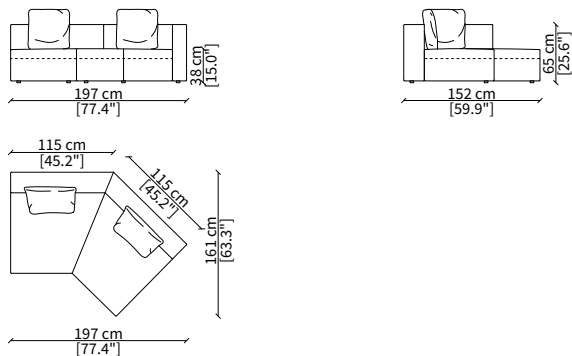

Dimensioni espresse in cm se non diversamente indicato.  
L'Azienda si riserva il diritto di apportare modifiche ai modelli senza preavviso.  
Tolleranza sulle misure indicate di +/- 2%.

Dimensions in centimeter if not differently indicated.  
The Company reserves the right to change the models without any advance notice.  
Tolerance on the given sizes +/- 2%.

## COOPER LARGE

Design Gianfranco Frigerio

### ELEMENTO DORMEUSE COMFORT / COMFORT DORMEUSE ELEMENT

cod. 10520

Dormeuse 197 cm / Dormeuse 197 cm

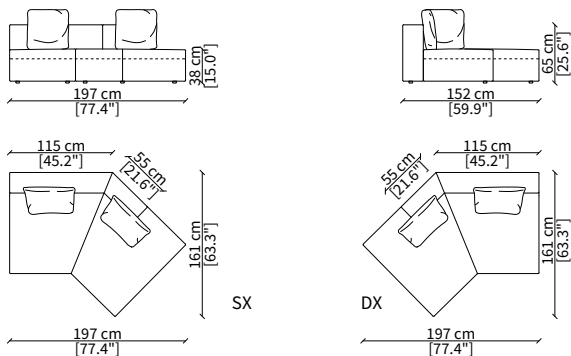

### ELEMENTI CHAISE LONGUE / CHAISE LONGUE ELEMENTS

cod. 10514

Elemento 90 cm / Element 90 cm

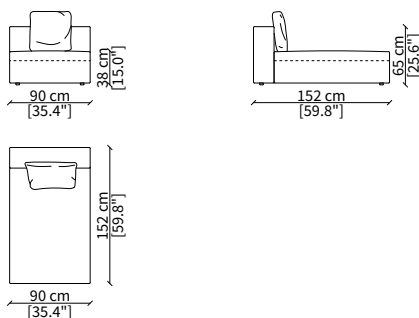

cod. 10515

Elemento 105 cm / Element 105 cm

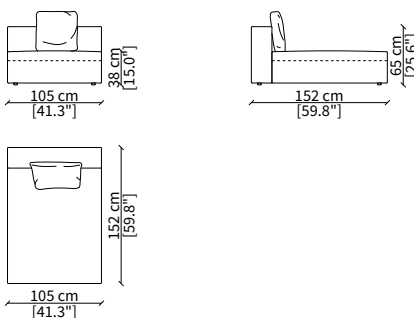

### POUFS

cod. 10807

Elemento 70x70 cm / Element 70x70 cm

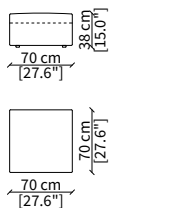

cod. 10416

Elemento 101x101 cm / Element 101x101 cm

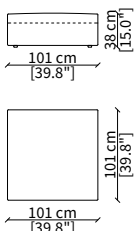

cod. 10417

Elemento 113x113 cm / Element 113x113 cm

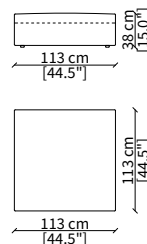

cod. 10422

Elemento 150x101 cm / Element 150x101 cm

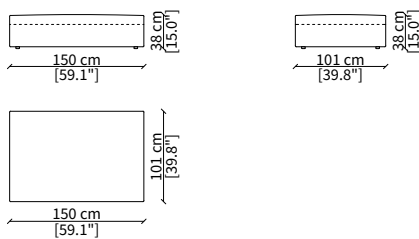

cod. 10423

Elemento 150x113 cm / Element 150x113 cm

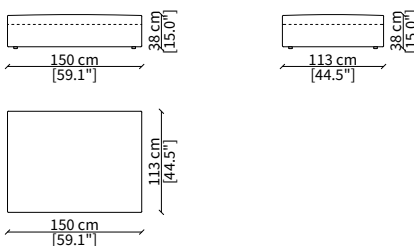

Dimensioni espresse in cm se non diversamente indicato.  
L'Azienda si riserva il diritto di apportare modifiche ai modelli senza preavviso.  
Tolleranza sulle misure indicate di +/- 2%.

Dimensions in centimeter if not differently indicated.  
The Company reserves the right to change the models without any advance notice.  
Tolerance on the given sizes +/- 2%.



## COOPER LARGE

Design Gianfranco Frigerio

### CUSCINI / CUSHIONS

#### cod. CO

Cuscino 58x40 cm / Cushion 58x40 cm

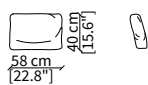

#### cod. CS

Cuscino 58x55 cm / Cushion 58x55 cm

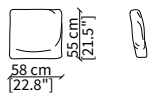

#### cod. COS

Cuscino 58x55 cm / Cushion 58x55 cm

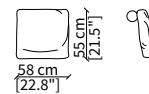

#### cod. 10424

Cuscino a libero posizionamento 57x53 cm  
Freestanding backrest 57x53 cm

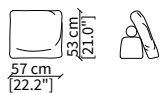

#### cod. 10425

Cuscino a libero posizionamento 78x53 cm  
Freestanding backrest 78x53 cm

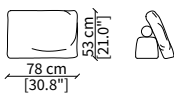

## COOPER JUNIOR Design Gianfranco Frigerio

### POLTRONA / ARMCHAIR

cod. 10800

Elemento 98x92 cm / Element 98x92 cm

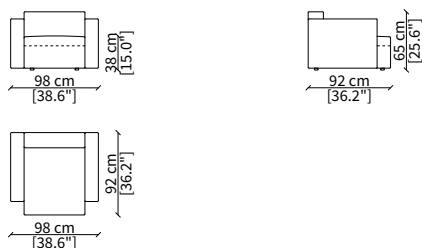

### ELEMENTI TERMINALI / TERMINAL ELEMENTS

cod. 10804

Elemento 83 cm / Element 83 cm

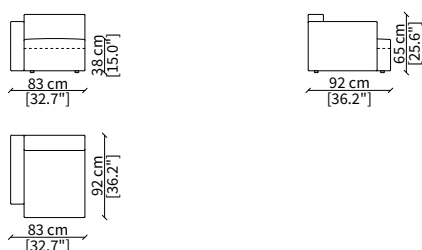

cod. 10805

Elemento 105 cm / Element 105 cm

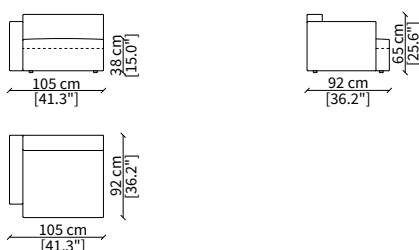

cod. 10806

Elemento 120 cm / Element 120 cm

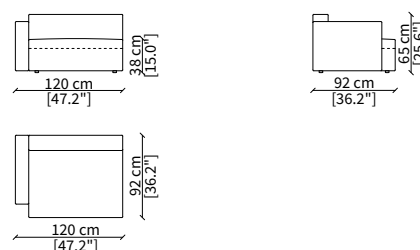

### ELEMENTI CENTRALI / CENTRAL ELEMENTS

cod. 10801

Elemento 68 cm / Element 68 cm

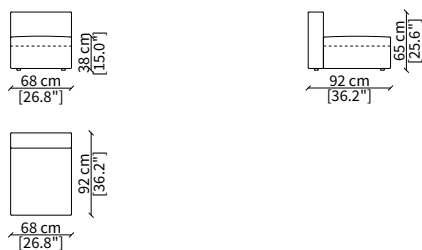

cod. 10802

Elemento 90 cm / Element 90 cm

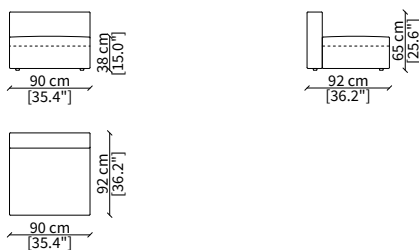

cod. 10803

Elemento 105 cm / Element 105 cm

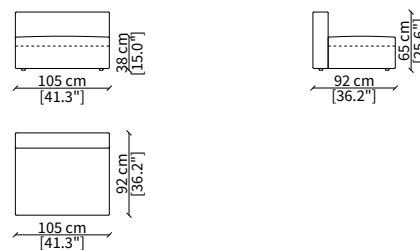

### POUF

cod. 10807

Elemento 70x70 cm / Element 70x70 cm

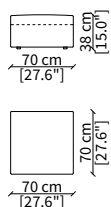

Dimensioni espresse in cm se non diversamente indicato.  
L'Azienda si riserva il diritto di apportare modifiche ai modelli senza preavviso.  
Tolleranza sulle misure indicate di +/- 2%.

Dimensions in centimeter if not differently indicated.  
The Company reserves the right to change the models without any advance notice.  
Tolerance on the given sizes +/- 2%.

## COOPER

Design Gianfranco Frigerio

### ESEMPI DI COMPOSIZIONI / COMPOSITION EXAMPLES

#### cod. 10400 - MSL + 10511

bracciolo MSL 101x23x55 cm cod. 10400  
centrale 180 cm cod. 10511

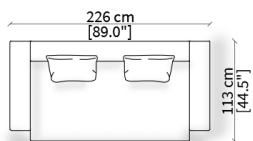

#### cod. 10400 - MSL + 10508

bracciolo MSL 101x23x55 cm cod. 10400  
centrale 105 cm cod. 10508

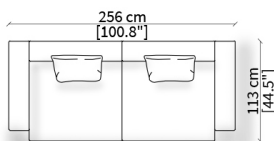

#### cod. 10400 - MSL + 10510 + 10405 - LSH + 10513

bracciolo MSL 101x23x55 cm cod. 10400  
centrale 150 cm cod. 10510  
bracciolo LSH 113x23x65 cm cod. 10405  
dormeuse centrale 150 cm cod. 10513

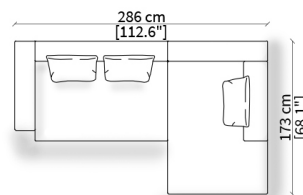

#### cod. 10400 - MSL + 10508 + 10520

bracciolo MSL 101x23x55 cm cod. 10400  
centrale 105 cm cod. 10508  
dormeuse comfort 197 cm cod. 10520

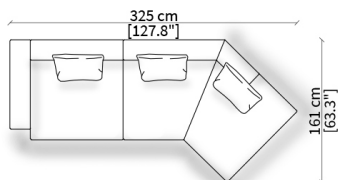

#### cod. 10400 - MSL + 10509 + 10515

bracciolo MSL 101x23x55 cm cod. 10400  
centrale 125 cm cod. 10509  
chaise longue 105 cm cod. 10515

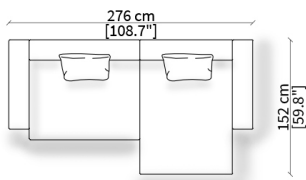

#### cod. 10416 + 10510 + 10521

pouf 101x101 cm cod. 10416  
centrale 150 cm cod. 10510  
dormeuse longue 150 cm cod. 10521

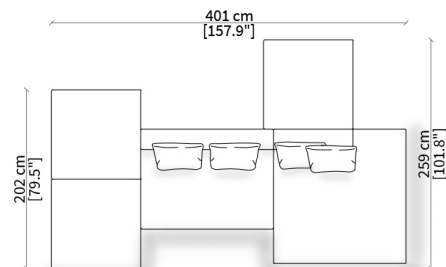

## COOPER

Design Gianfranco Frigerio

### TESSUTO / FABRIC



Asole



Avignone



Bellagio



Butterfly



Caprera



Capri



Caracalla



Chioggia

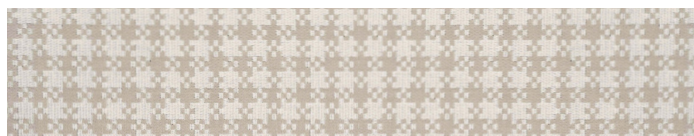

Candotti



Dorian

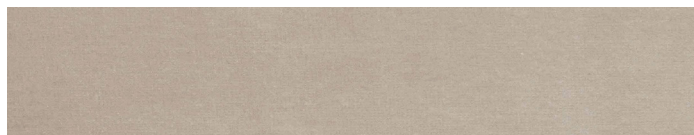

Fiocco



Il Trovatore



Ischia



Katmandu



La Boheme



Lario



Linosa



Maddalena

*La presente tabella tessile, pelli e materiali è a solo titolo indicativo e non vincolante. L'effettiva disponibilità di ogni materiale deve essere preventivamente verificata con l'ufficio commerciale Frigerio.*

*L'azienda si riserva il diritto di sospendere la disponibilità di qualsiasi materiale senza alcun obbligo di preavviso sulla presente scheda tecnica.*

*I colori visualizzati, per ovvie ragioni tecniche, sono indicativi e possono differire dall'originale. Fare riferimento al listino prezzi per uso e disponibilità di ogni singola finitura.*

*The above textile, leather and material charts are only indicative and not binding. The actual availability of any material shall be checked in advance with the Frigerio commercial office. The company reserves the right to discontinue any material without any obligation of due notice on this technical data sheet.*

*The colours visualized, for obvious technical reasons, are indicative and may differ from the original.*

*Please refer to price list for use and availability of each finish.*

COOPER  
Design Gianfranco Frigerio

## TESSUTO / FABRIC



Moritz



Nebraska

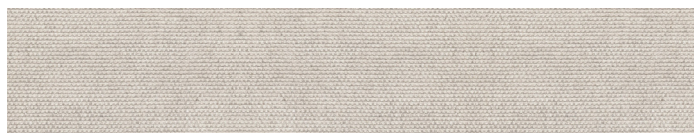

Padova

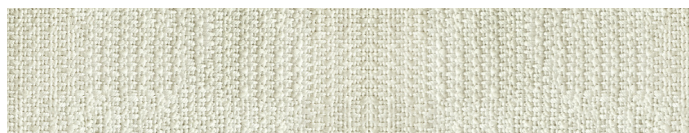

Panarea



Piazza Di Spagna

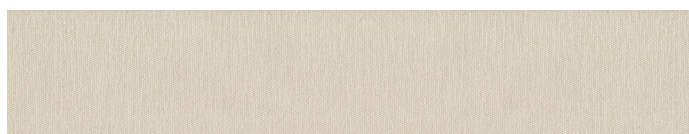

Ponza



Porto Cervo

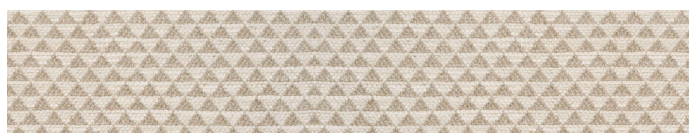

Porto Rotondo

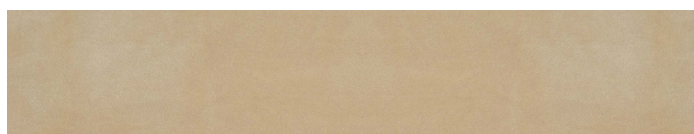

Rem



San Remo

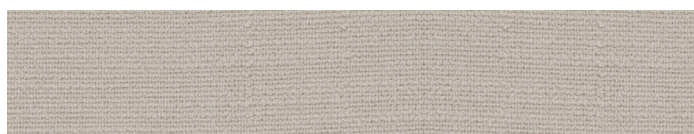

Tellaro



Tenerife

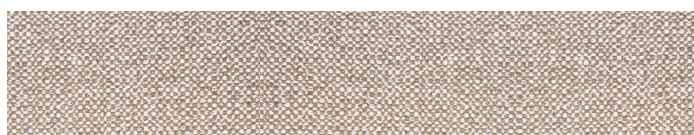

Turandot



Ventotene



Villa Borghese

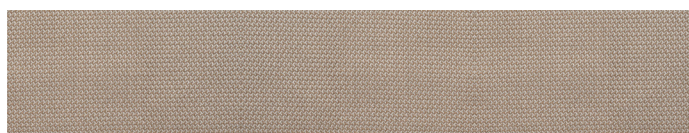

Villa d'Este

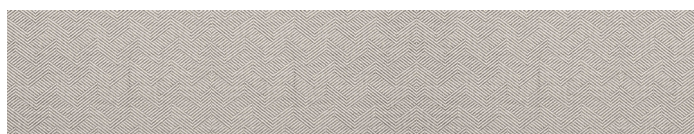

Villa Flori



VF 1650

*La presente tabella tessile, pelli e materiali è a solo titolo indicativo e non vincolante. L'effettiva disponibilità di ogni materiale deve essere preventivamente verificata con l'ufficio commerciale Frigerio.*

*L'azienda si riserva il diritto di sospendere la disponibilità di qualsiasi materiale senza alcun obbligo di preavviso sulla presente scheda tecnica.*

*I colori visualizzati, per ovvie ragioni tecniche, sono indicativi e possono differire dall'originale. Fare riferimento al listino prezzi per uso e disponibilità di ogni singola finitura.*

*The above textile, leather and material charts are only indicative and not binding. The actual availability of any material shall be checked in advance with the Frigerio commercial office. The company reserves the right to discontinue any material without any obligation of due notice on this technical data sheet.*

*The colours visualized, for obvious technical reasons, are indicative and may differ from the original.*

*Please refer to price list for use and availability of each finish.*

## COOPER

Design Gianfranco Frigerio

### TESSUTO / FABRIC

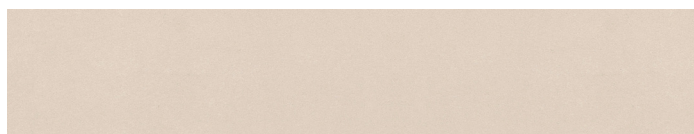

VF 1700



VF 1750



VF 1800

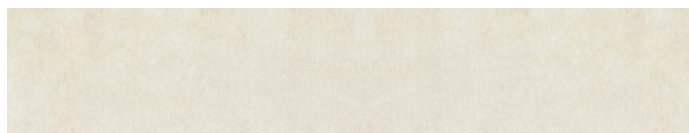

VF 2450



VF 2550

### PELLE / LEATHER

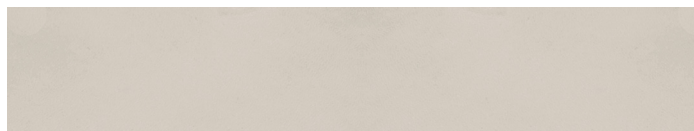

Nubuk

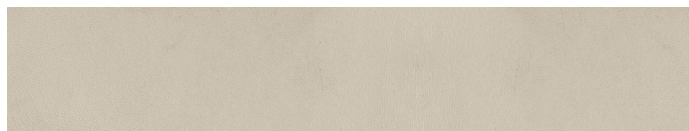

Anilina

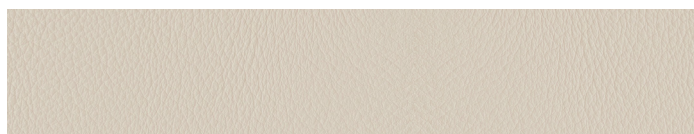

Siena



Bolgheri

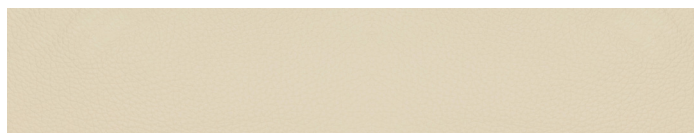

Pisa

### PIEDINI / FEET



Color Nero  
Black Colour

La presente tabella tessile, pelli e materiali è a solo titolo indicativo e non vincolante. L'effettiva disponibilità di ogni materiale deve essere preventivamente verificata con l'ufficio commerciale Frigerio.

L'azienda si riserva il diritto di sospendere la disponibilità di qualsiasi materiale senza alcun obbligo di preavviso sulla presente scheda tecnica.

I colori visualizzati, per ovvie ragioni tecniche, sono indicativi e possono differire dall'originale. Fare riferimento al listino prezzi per uso e disponibilità di ogni singola finitura.

The above textile, leather and material charts are only indicative and not binding. The actual availability of any material shall be checked in advance with the Frigerio commercial office. The company reserves the right to discontinue any material without any obligation of due notice on this technical data sheet.

The colours visualized, for obvious technical reasons, are indicative and may differ from the original.

Please refer to price list for use and availability of each finish.