

MILLER

Design Gianfranco Frigerio

Struttura: legno multistrato imbottito in poliuretano espanso indeformabile rivestito in tessuto protettivo accoppiato.

Cuscini seduta: poliuretano espanso indeformabile.

Piano seduta trapuntato: accoppiato a fibra sintetica.

Cuscini schienale: piuma d'oca (Assopiuma).

Piedini: neri.

Rivestimento: sfoderabile in tessuto, fisso in pelle. Rivestimento trapuntato sfoderabile e lavabile esclusivamente a secco.

Profilo: esclusivamente sul cuscino seduta, nello stesso materiale e colore del rivestimento.

ACCESSORI:

| **libreria Schienale:** composta da vani a giorno e vassoi non removibili in legno, fissati ad una struttura in metallo verniciato color brunito.

Da abbinare sul retro di qualsiasi elemento, non è fissato al divano.

| **elemento angolare:** realizzabile attraverso l'uso di un elemento angolare.

| **pouf e volumi pouf:** collezione di pouf coordinati in differenti misure con rivestimento liscio o trapuntato e volumi pouf in differenti misure con rivestimento trapuntato.

| **cuscini decorativi:** cuscini decorativi in dimensioni specifiche in piuma d'oca e la possibilità di aggiungere un elemento poggiatesta.

| **tavolini:** volumi monoblocco in varie dimensioni in ceramica nei colori della collezione Frigerio oppure rivestiti in cuoio.

VERSIONE MILLER BRACCIOLLO: versione con bracciolo leggermente arrotondato.

VERSIONE MILLER TOP: struttura con top imbottito e schienale sporgente, che servono da appoggio e contenimento per accessori.

ACCESSORI MILLER TOP:

| Bracciolo CABINET

| Bracciolo VOLUME SOFT

| Bracciolo VOLUME PAD

Varianti: combinale con gli altri elementi della collezione Miller.

VERSIONE MILLER OPEN: struttura con schienale sporgente, che serve da contenimento accessori posizionati a terra.

ACCESSORI MILLER OPEN:

| Bracciolo WOOD

| Bracciolo DAY LOW

Varianti: combinale con gli altri elementi della collezione Miller.

Structure: plywood padded with non-deformable polyurethane foam covered with doubled protective fabric.

Seat cushion: non-deformable polyurethane foam.

Quilted top seat cover: doubled with synthetic fibre layer.

Back cushions: goose down (Assopiuma).

Feet: black.

Cover: removable in fabric, fix in leather. Quilted covers removable, dry clean only.

Piping: on seat cushion only, in the same material and colour as the cover.

ACCESSORIES:

| **bookcase for backrest:** composed by open compartments and non-removable trays in wood, fixed to a structure in metal burnished painted.

To be placed on the back of any element, it is not fixed to the sofa.

| **corner element:** realized with the use of a given corner element.

| **pouf and volume pouf:** collection of coordinated poufs in different sizes with plain or quilted cover and volume pouf in different sizes with quilted cover.

| **beauty cushions:** cushions in specific sizes in goose down and possibility to add a headrest element.

| **small tables:** monobloc volumes in different sizes in ceramic in the colours of the Frigerio collection or covered in hide leather.

VERSION MILLER ARMREST: classical version with armrest slightly rounded.

VERSION MILLER TOP: structure with top and longer back suitable for supporting and containing accessories.

ACCESSORIES MILLER TOP:

| Armrest CABINET

| Armrest VOLUME SOFT

| Armrest VOLUME PAD

Variants: to be combined with the other elements of the Miller Collection.

VERSION MILLER OPEN: structure with longer back suitable for containing elements resting on floor.

ACCESSORIES MILLER OPEN:

| Armrest WOOD

| Armrest DAY LOW

Variants: to be combined with the other elements of the Miller Collection.



MILLER

Design Gianfranco Frigerio

DIVANI / SOFAS

cod. 15700

Divano PLAIN 180 cm / Sofa PLAIN 180 cm

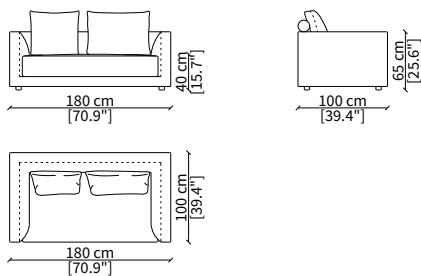

cod. 15400

Divano QUILT 180 cm / Sofa QUILT 180 cm

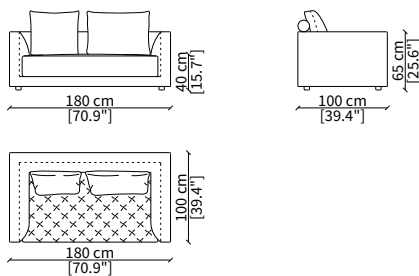

ELEMENTI DORMEUSE / DORMEUSE ELEMENTS

cod. 15721

Elemento PLAIN 155 cm / Element PLAIN 155 cm

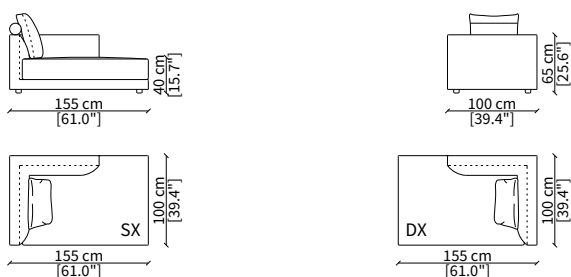

cod. 15421

Elemento QUILT 155 cm / Element QUILT 155 cm

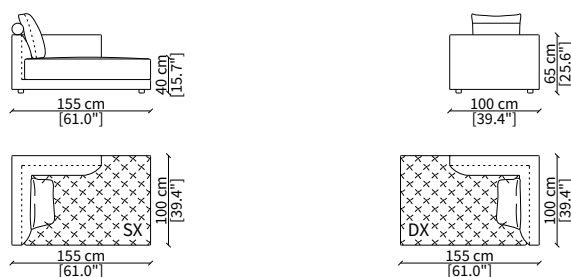

cod. 15722

Elemento PLAIN 220 cm / Element PLAIN 220 cm

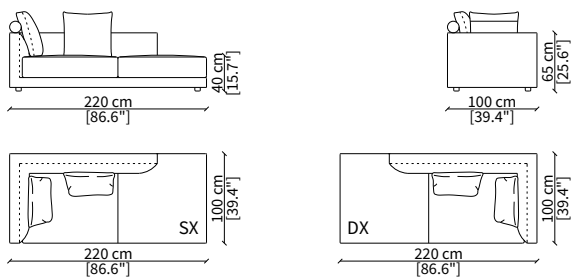

cod. 15422

Elemento QUILT 220 cm / Element QUILT 220 cm

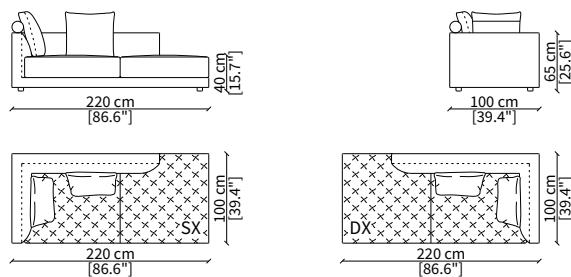

ELEMENTI DORMEUSE POUF / DORMEUSE POUF ELEMENTS

cod. 15723

Elemento PLAIN 260 cm / Element PLAIN 260 cm

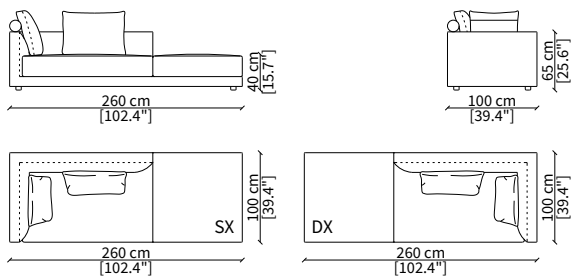

cod. 15423

Elemento QUILT 260 cm / Element QUILT 260 cm

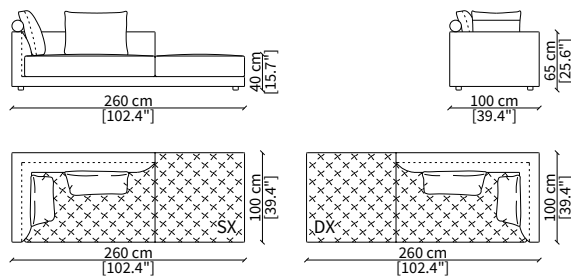

Dimensioni espresse in cm se non diversamente indicato.
L'Azienda si riserva il diritto di apportare modifiche ai modelli senza preavviso.
Tolleranza sulle misure indicate di +/- 2%.

Dimensions in centimeter if not differently indicated.
The Company reserves the right to change the models without any advance notice.
Tolerance on the given sizes +/- 2%.

MILLER

Design Gianfranco Frigerio

cod. 15610

Elemento QUILTED POUF 260 cm / Element QUILTED POUF 260 cm

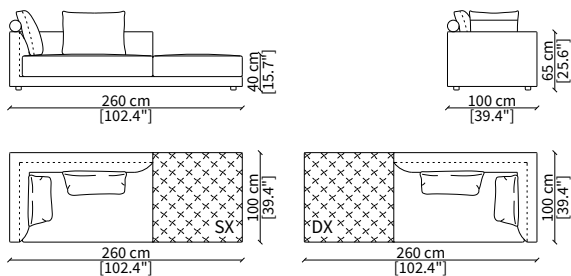

ELEMENTI CHAISE LONGUE / CHAISE LONGUE ELEMENTS

cod. 15719

Elemento PLAIN 100 cm / Element PLAIN 100 cm

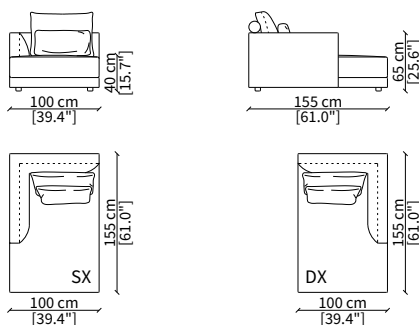

cod. 15419

Elemento QUILT 100 cm / Element QUILT 100 cm

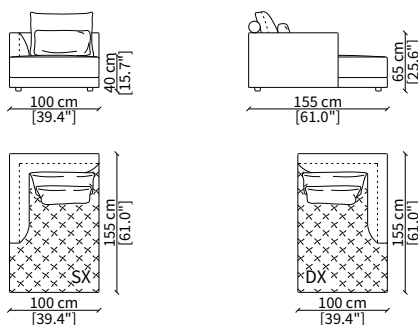

cod. 15720

Elemento PLAIN 120 cm / Element PLAIN 120 cm

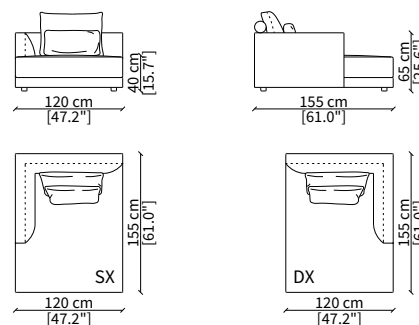

cod. 15420

Elemento QUILT 120 cm / Element QUILT 120 cm

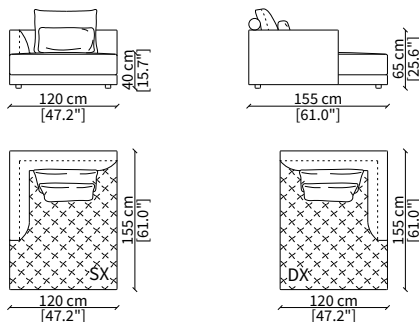

ELEMENTI TERMINALI / TERMINAL ELEMENTS

cod. 15713

Terminale PLAIN 100 cm / Terminal PLAIN 100 cm

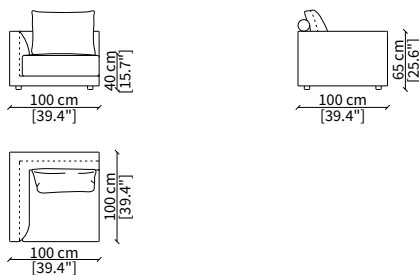

cod. 15413

Terminale QUILT 100 cm / Terminal QUILT 100 cm

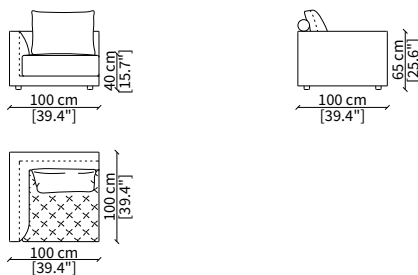

cod. 15714

Terminale PLAIN 110 cm / Terminal PLAIN 110 cm

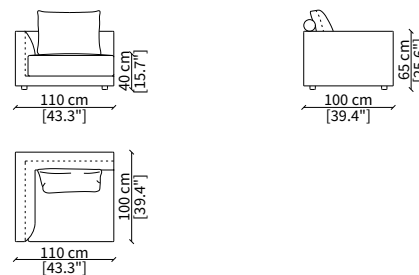

Dimensioni espresse in cm se non diversamente indicato.
L'azienda si riserva il diritto di apportare modifiche ai modelli senza preavviso.
Tolleranza sulle misure indicate di +/- 2%.

Dimensions in centimeter if not differently indicated.
The Company reserves the right to change the models without any advance notice.
Tolerance on the given sizes +/- 2%.

MILLER

Design Gianfranco Frigerio

cod. 15414

Terminale QUILT 110 cm / Terminal QUILT 110 cm

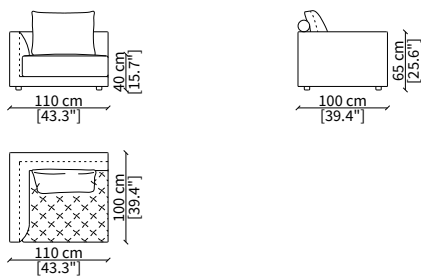

cod. 15715

Terminale PLAIN 120 cm / Terminal PLAIN 120 cm

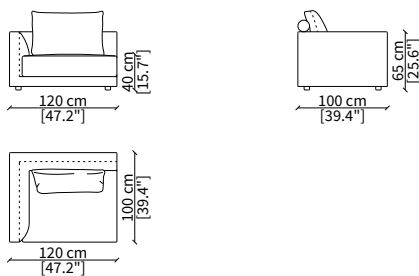

cod. 15415

Terminale QUILT 120 cm / Terminal QUILT 120 cm

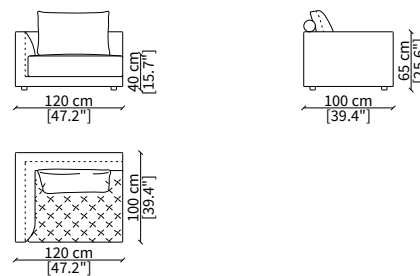

cod. 15716

Terminale PLAIN 130 cm / Terminal PLAIN 130 cm

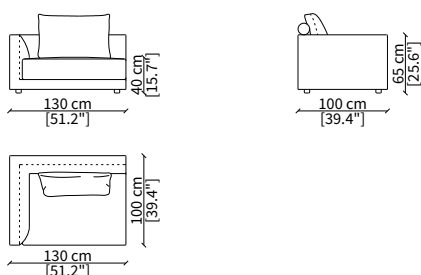

cod. 15416

Terminale QUILT 130 cm / Terminal QUILT 130 cm

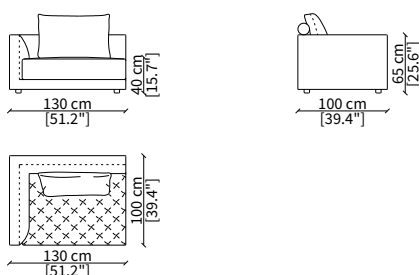

cod. 15717

Terminale PLAIN 140 cm / Terminal PLAIN 140 cm

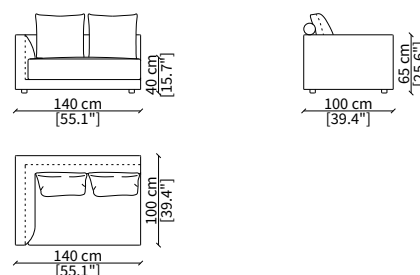

cod. 15417

Terminale QUILT 140 cm / Terminal QUILT 140 cm

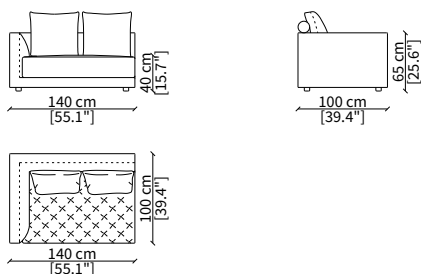

cod. 15718

Terminale PLAIN 160 cm / Terminal PLAIN 160 cm

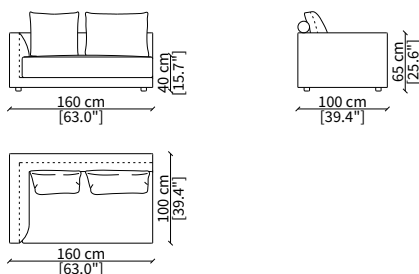

cod. 15418

Terminale QUILT 160 cm / Terminal QUILT 160 cm

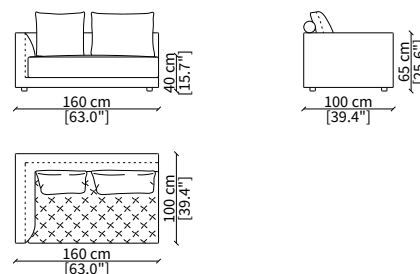

ELEMENTI CENTRALI / CENTRAL ELEMENTS

cod. 15701

Elemento PLAIN 80 cm / Element PLAIN 80 cm

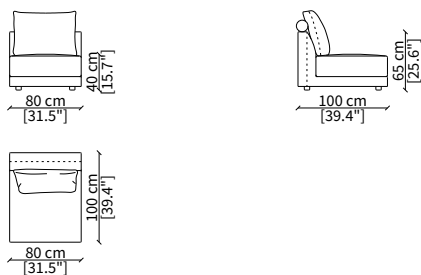

cod. 15401

Elemento QUILT 80 cm / Element QUILT 80 cm

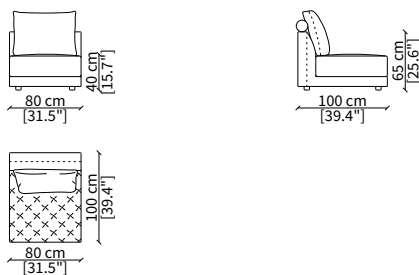

cod. 15702

Elemento PLAIN 90 cm / Element PLAIN 90 cm

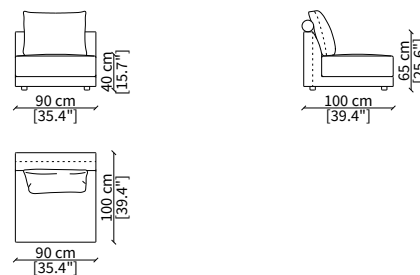

Dimensioni espresse in cm se non diversamente indicato.
L'Azienda si riserva il diritto di apportare modifiche ai modelli senza preavviso.
Tolleranza sulle misure indicate di +/- 2%.

Dimensions in centimeter if not differently indicated.
The Company reserves the right to change the models without any advance notice.
Tolerance on the given sizes +/- 2%.

MILLER

Design Gianfranco Frigerio

cod. 15402

Elemento QUILT 90 cm / Element QUILT 90 cm

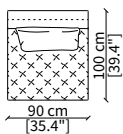
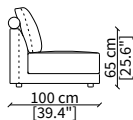
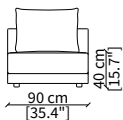

cod. 15703

Elemento PLAIN 100 cm / Element PLAIN 100 cm

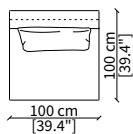
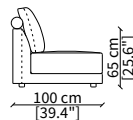
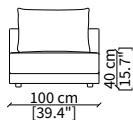

cod. 15403

Elemento QUILT 100 cm / Element QUILT 100 cm

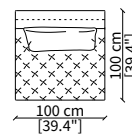
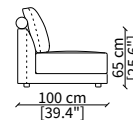
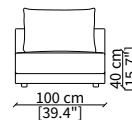

cod. 15704

Elemento PLAIN 110 cm / Element PLAIN 110 cm

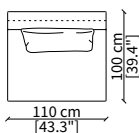
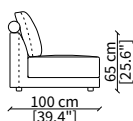
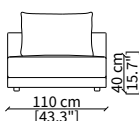

cod. 15404

Elemento QUILT 110 cm / Element QUILT 110 cm

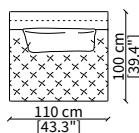
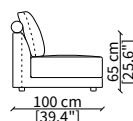
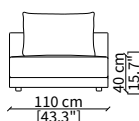

cod. 15705

Elemento PLAIN 120 cm / Element PLAIN 120 cm

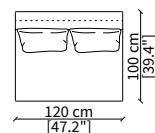
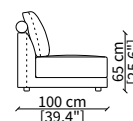
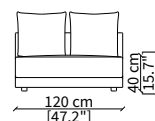

cod. 15405

Elemento QUILT 120 cm / Element QUILT 120 cm

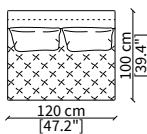
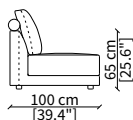
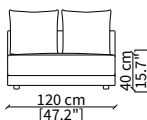

cod. 15706

Elemento PLAIN 140 cm / Element PLAIN 140 cm

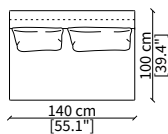
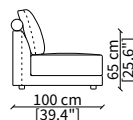
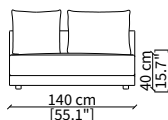

cod. 15406

Elemento QUILT 140 cm / Element QUILT 140 cm

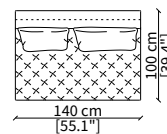
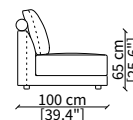
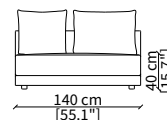

ELEMENTI DORMEUSE CENTRALI / CENTRAL DORMEUSE ELEMENTS

cod. 15709

Elemento PLAIN 135 cm / Element PLAIN 135 cm

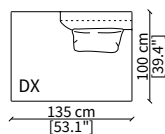
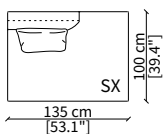
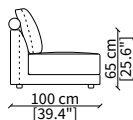
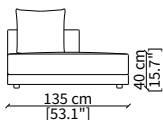

cod. 15409

Elemento QUILT 135 cm / Element QUILT 135 cm

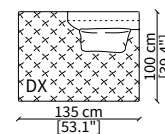
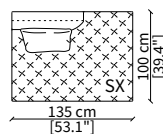
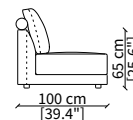
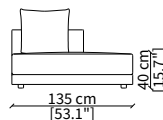

Dimensioni espresse in cm se non diversamente indicato.
L'Azienda si riserva il diritto di apportare modifiche ai modelli senza preavviso.
Tolleranza sulle misure indicate di +/- 2%.

Dimensions in centimeter if not differently indicated.
The Company reserves the right to change the models without any advance notice.
Tolerance on the given sizes +/- 2%.

MILLER

Design Gianfranco Frigerio

cod. 15710

Elemento PLAIN 200 cm / Element PLAIN 200 cm

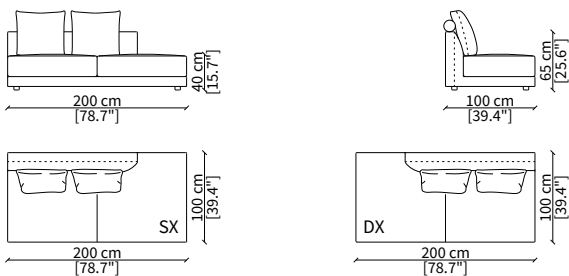

cod. 15410

Elemento QUILT 200 cm / Element QUILT 200 cm

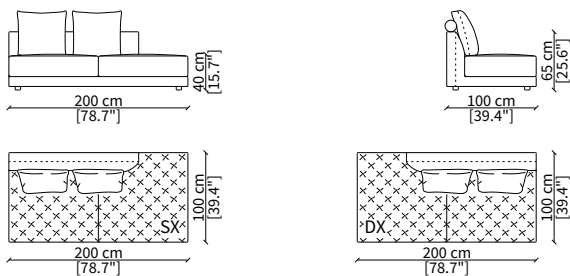

ELEMENTI CENTRALI DORMEUSE POUF / CENTRAL DORMEUSE POUF ELEMENTS

cod. 15711

Elemento PLAIN 240 cm / Element PLAIN 240 cm

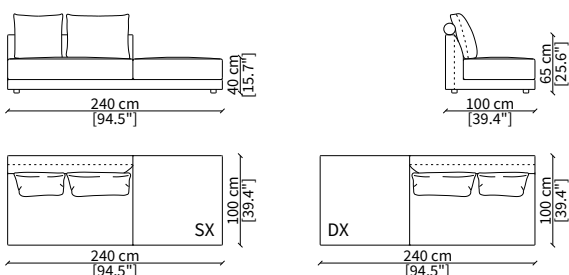

cod. 15411

Elemento QUILT 240 cm / Element QUILT 240 cm

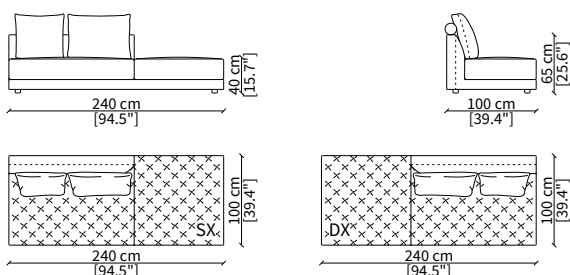

cod. 15607

Elemento QUILTED POUF 240 cm / Element QUILTED POUF 240 cm

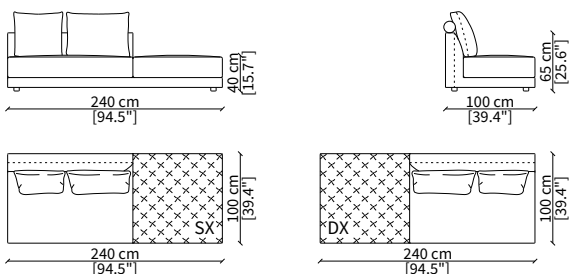

ELEMENTI CHAISE LONGUE CENTRALI / CENTRAL CHAISE LONGUE ELEMENTS

cod. 15707

Elemento PLAIN 100 cm / Element PLAIN 100 cm

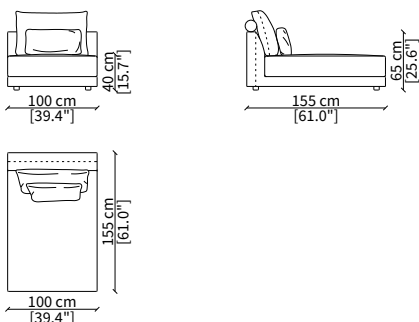

cod. 15407

Elemento QUILT 100 cm / Element QUILT 100 cm

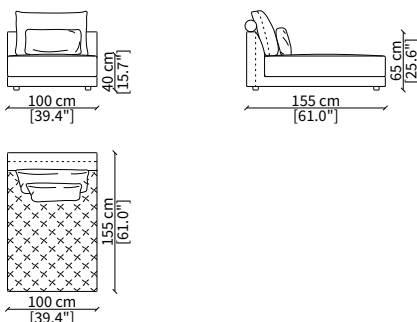

cod. 15708

Elemento PLAIN 120 cm / Element PLAIN 120 cm

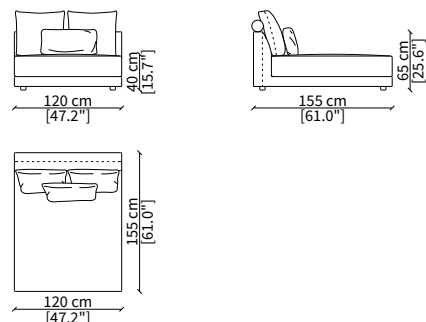

Dimensioni espresse in cm se non diversamente indicato.
L'Azienda si riserva il diritto di apportare modifiche ai modelli senza preavviso.
Tolleranza sulle misure indicate di +/- 2%.

Dimensions in centimeter if not differently indicated.
The Company reserves the right to change the models without any advance notice.
Tolerance on the given sizes +/- 2%.

MILLER

Design Gianfranco Frigerio

cod. 15408

Elemento QUILT 120 cm / Element QUILT 120 cm

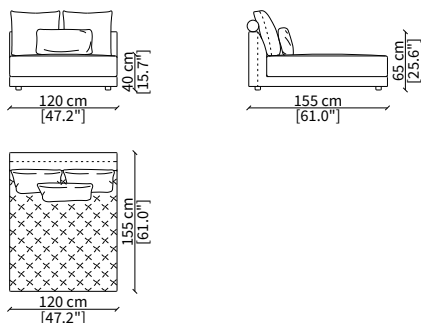

ELEMENTI LONGUE / LONGUE ELEMENTS

cod. 15712S

Elemento PLAIN 80 cm / Element PLAIN 80 cm

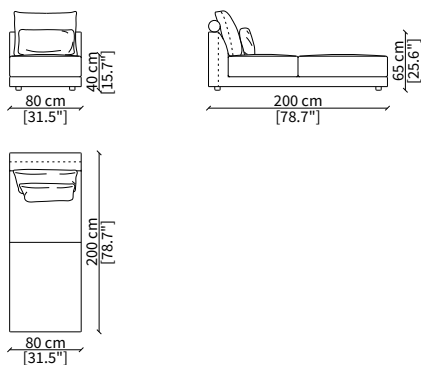

cod. 15412S

Elemento QUILT 80 cm / Element QUILT 80 cm

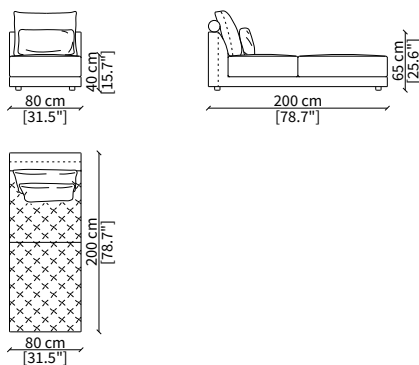

cod. 15608

Elemento una seduta QUILT 80 cm
Element one seat QUILT 80 cm

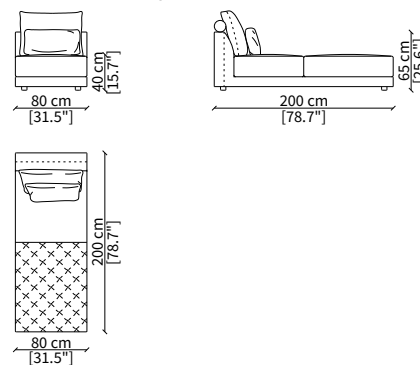

cod. 15712L

Elemento PLAIN 100 cm / Element PLAIN 100 cm

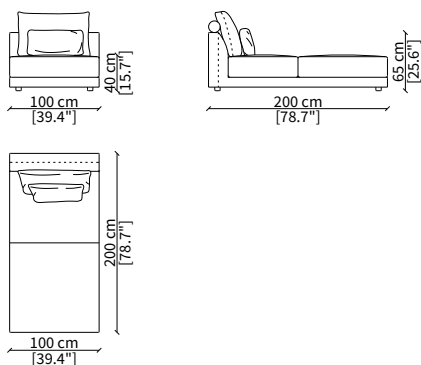

cod. 15412L

Elemento QUILT 100 cm / Element QUILT 100 cm

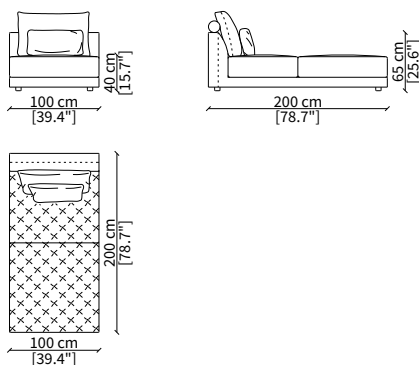

cod. 15609

Elemento una seduta QUILT 100 cm
Element one seat QUILT 100 cm

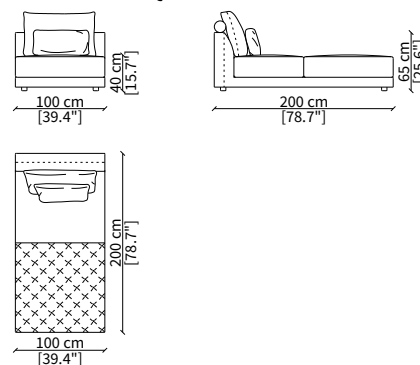

Dimensioni espresse in cm se non diversamente indicato.
L'Azienda si riserva il diritto di apportare modifiche ai modelli senza preavviso.
Tolleranza sulle misure indicate di +/- 2%.

Dimensions in centimeter if not differently indicated.
The Company reserves the right to change the models without any advance notice.
Tolerance on the given sizes +/- 2%.

MILLER

Design Gianfranco Frigerio

ELEMENTI ANGOLO / CORNER ELEMENTS

cod. 15724

Elemento PLAIN 100 cm / Element PLAIN 100 cm

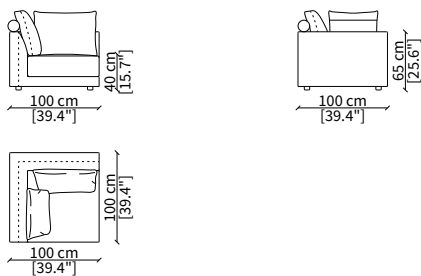

cod. 15424

Elemento QUILT 100 cm / Element QUILT 100 cm

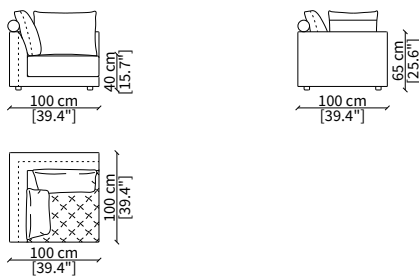

ELEMENTI ANGOLO CURVO / CURVED CORNER ELEMENTS

cod. 15825

Elemento PLAIN 100 cm / Element PLAIN 100 cm

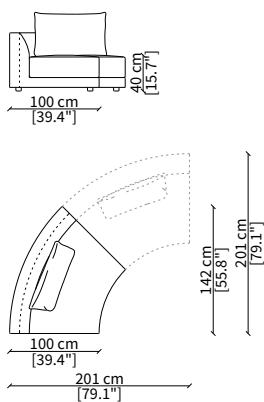

cod. 15826

Elemento QUILT 100 cm / Element QUILT 100 cm

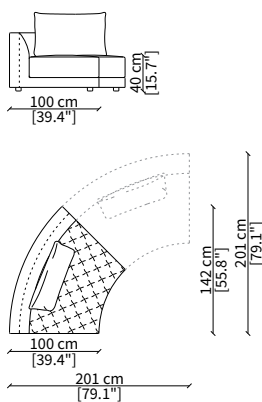

ELEMENTI TERMINALI ANGOLO / TERMINAL CORNER ELEMENTS

cod. 15725

Elemento PLAIN 110 cm / Element PLAIN 110 cm

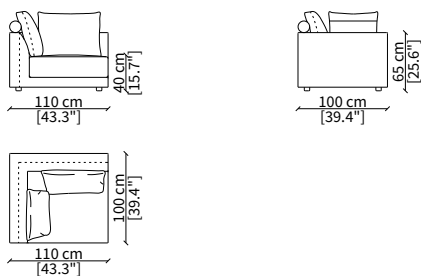

cod. 15425

Elemento QUILT 110 cm / Element QUILT 110 cm

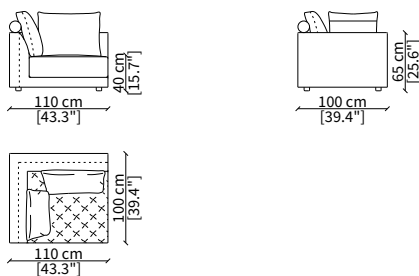

cod. 15726

Elemento PLAIN 120 cm / Element PLAIN 120 cm

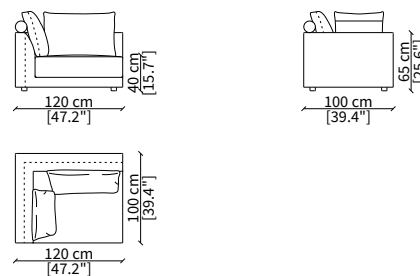

cod. 15426

Elemento QUILT 120 cm / Element QUILT 120 cm

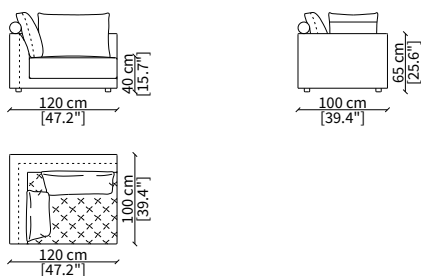

cod. 15727

Elemento PLAIN 130 cm / Element PLAIN 130 cm

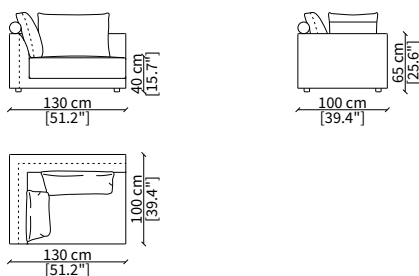

cod. 15427

Elemento QUILT 130 cm / Element QUILT 130 cm

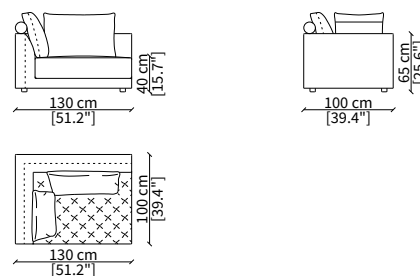

Dimensioni espresse in cm se non diversamente indicato.
L'Azienda si riserva il diritto di apportare modifiche ai modelli senza preavviso.
Tolleranza sulle misure indicate di +/- 2%.

Dimensions in centimeter if not differently indicated.
The Company reserves the right to change the models without any advance notice.
Tolerance on the given sizes +/- 2%.

MILLER

Design Gianfranco Frigerio

cod. 15728

Elemento PLAIN 140 cm / Element PLAIN 140 cm

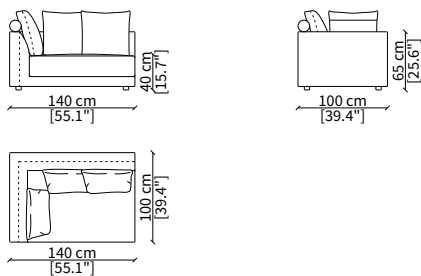

cod. 15428

Elemento QUILT 140 cm / Element QUILT 140 cm

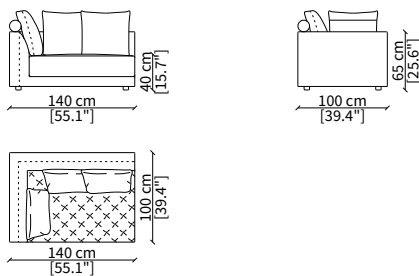

cod. 15729

Elemento PLAIN 160 cm / Element PLAIN 160 cm

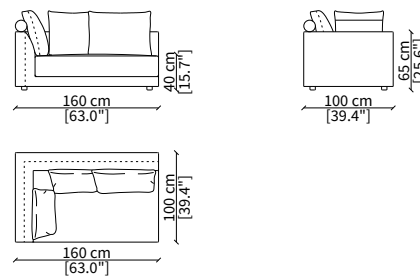

cod. 15429

Elemento QUILT 160 cm / Element QUILT 160 cm

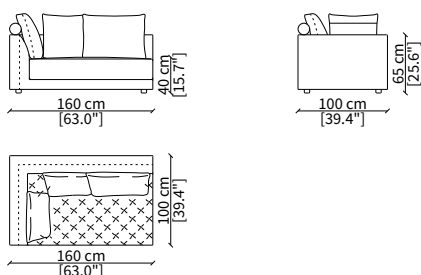

ELEMENTI DORMEUSE ANGOLO / DORMEUSE CORNER ELEMENTS

cod. 15732

Elemento PLAIN 155 cm / Element PLAIN 155 cm

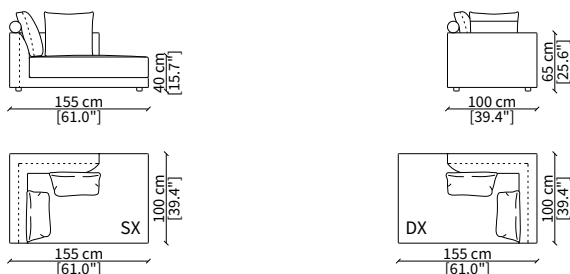

cod. 15432

Elemento QUILT 155 cm / Element QUILT 155 cm

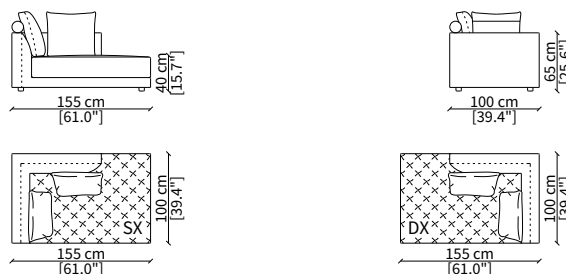

cod. 15733

Elemento PLAIN 220 cm / Element PLAIN 220 cm

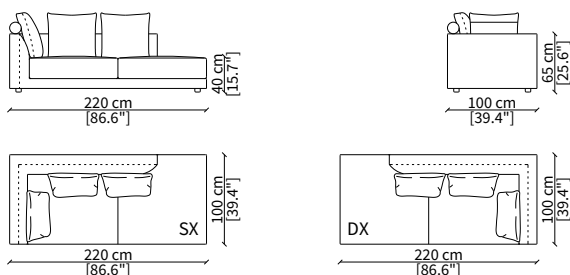

cod. 15433

Elemento QUILT 220 cm / Element QUILT 220 cm

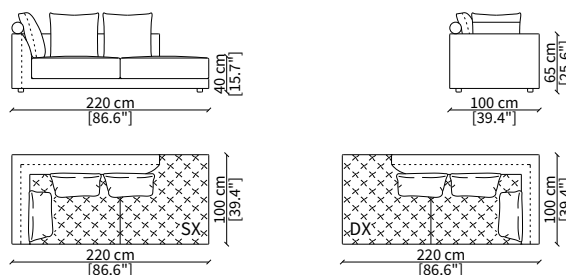

Dimensioni espresse in cm se non diversamente indicato.
L'Azienda si riserva il diritto di apportare modifiche ai modelli senza preavviso.
Tolleranza sulle misure indicate di +/- 2%.

Dimensions in centimeter if not differently indicated.
The Company reserves the right to change the models without any advance notice.
Tolerance on the given sizes +/- 2%.

MILLER

Design Gianfranco Frigerio

ELEMENTI DORMEUSE POUF ANGOLO / DORMEUSE POUF CORNER ELEMENTS

cod. 15734

Elemento PLAIN 260 cm / Element PLAIN 260 cm

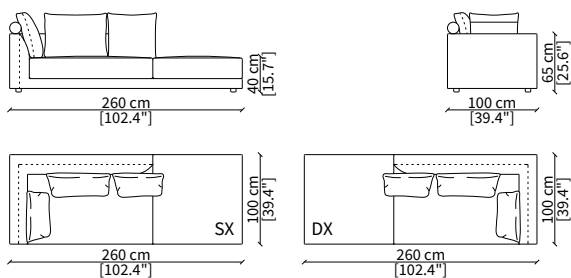

cod. 15434

Elemento QUILT 260 cm / Element QUILT 260 cm

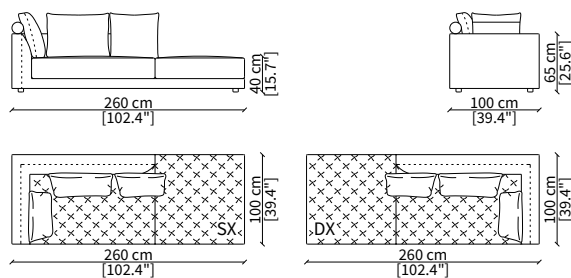

cod. 15611

Elemento QUILTED POUF 260 cm / Element QUILTED POUF 260 cm

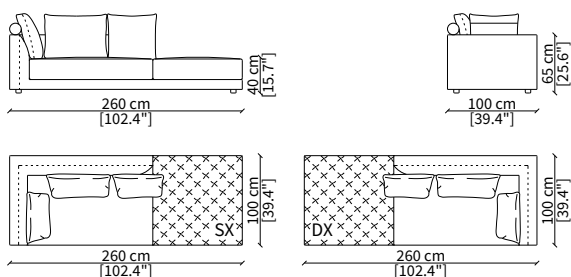

ELEMENTI CHAISE LONGUE ANGOLO / CORNER CHAISE LONGUE ELEMENTS

cod. 15730

Elemento PLAIN 100 cm / Element PLAIN 100 cm

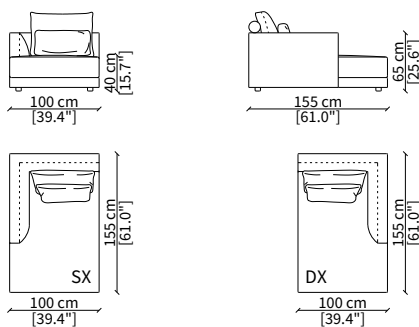

cod. 15430

Elemento QUILT 100 cm / Element QUILT 100 cm

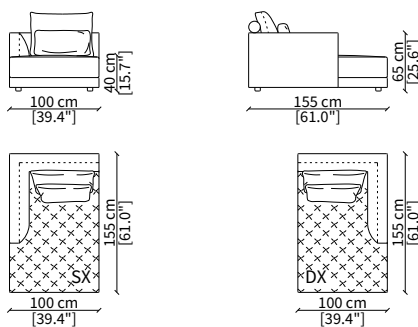

cod. 15731

Elemento PLAIN 120 cm / Element PLAIN 120 cm

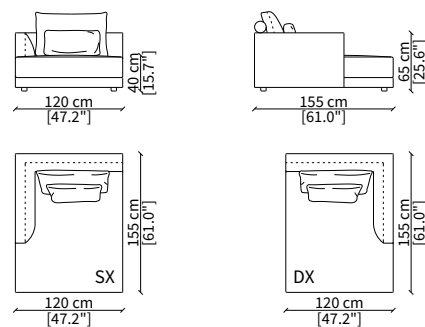

cod. 15431

Elemento QUILT 120 cm / Element QUILT 120 cm

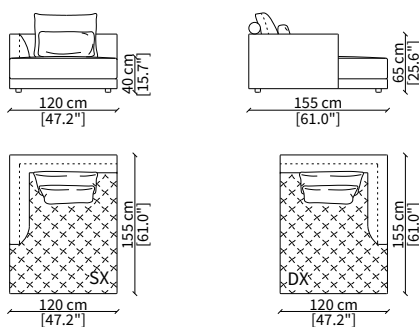

Dimensioni espresse in cm se non diversamente indicato.
L'Azienda si riserva il diritto di apportare modifiche ai modelli senza preavviso.
Tolleranza sulle misure indicate di +/- 2%.

Dimensions in centimeter if not differently indicated.
The Company reserves the right to change the models without any advance notice.
Tolerance on the given sizes +/- 2%.

MILLER

Design Gianfranco Frigerio

BRACCIOLI / ARMRESTS

cod. 15527

Bracciolo DAY LOW 100 cm / Armrest DAY LOW 100 cm

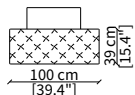
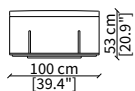

cod. 15539

Bracciolo WOOD 100 cm / Armrest WOOD 100 cm

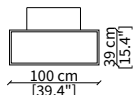
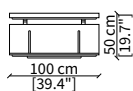

LIBRERIE / BOOKCASES

cod. 15544

Elemento 80x30 cm / Element 80x30 cm

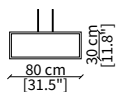
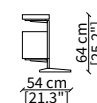
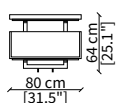

cod. 15545

Elemento 100x30 cm / Element 100x30 cm

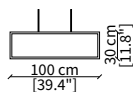
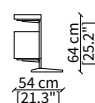
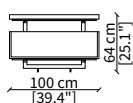

cod. 15547

Elemento 140x30 cm / Element 140x30 cm

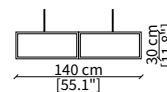
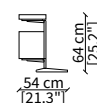
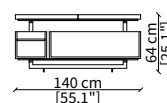

POUFS

cod. 15735

Pouf PLAIN 80x80 cm

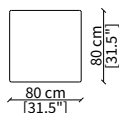
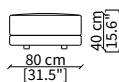

cod. 15435

Pouf QUILT 80x80 cm

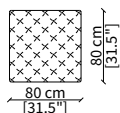
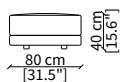

cod. 15736

Pouf PLAIN 100x100 cm

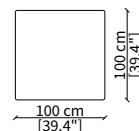
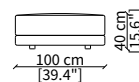

cod. 15436

Pouf QUILT 100x100 cm

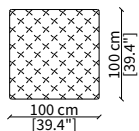
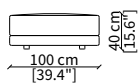

cod. 15737

Pouf PLAIN 160x80 cm

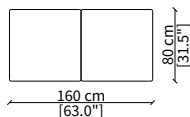
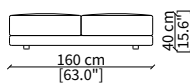

cod. 15437

Pouf QUILT 160x80 cm

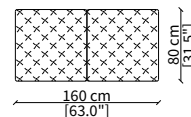
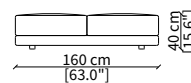

Dimensioni espresse in cm se non diversamente indicato.
L'Azienda si riserva il diritto di apportare modifiche ai modelli senza preavviso.
Tolleranza sulle misure indicate di +/- 2%.

Dimensions in centimeter if not differently indicated.
The Company reserves the right to change the models without any advance notice.
Tolerance on the given sizes +/- 2%.

MILLER

Design Gianfranco Frigerio

cod. 15738

Pouf PLAIN 200x100 cm

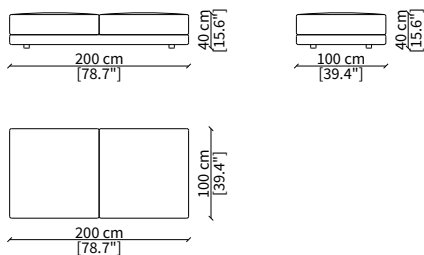

cod. 15438

Pouf QUILT 160x80 cm

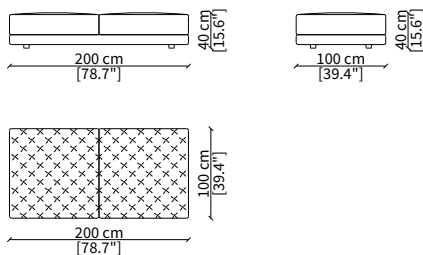

cod. 15749

Pouf PLAIN 100x60 cm

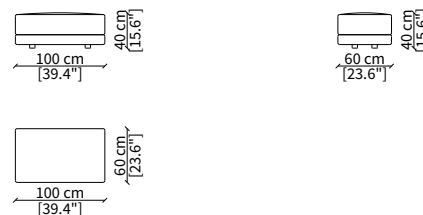

cod. 15449

Pouf QUILT 100x60 cm



cod. 15896

Pouf PLAIN 100x80 cm

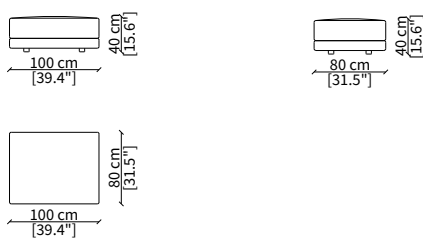

cod. 15596

Pouf QUILT 100x80 cm

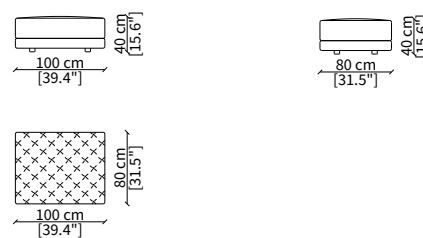

cod. 15827

Pouf curvo PLAIN 142x100 cm
Curved stool PLAIN 142x100 cm

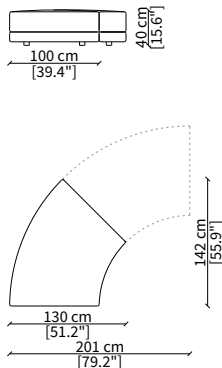

cod. 15828

Pouf curvo QUILT 142x100 cm
Curved stool QUILT 142x100 cm

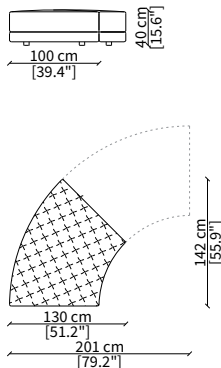

VOLUMI POUF / POUF VOLUMES

cod. 15439

Elemento 80x40 cm / Element 80x40 cm



cod. 15440

Elemento 100x40 cm / Element 100x40 cm

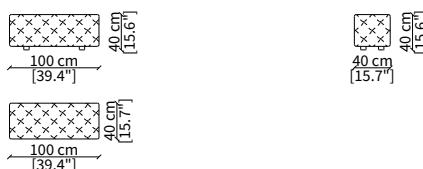

cod. 15441

Elemento 120x40 cm / Element 120x40 cm



Dimensioni espresse in cm se non diversamente indicato.
L'Azienda si riserva il diritto di apportare modifiche ai modelli senza preavviso.
Tolleranza sulle misure indicate di +/- 2%.

Dimensions in centimeter if not differently indicated.
The Company reserves the right to change the models without any advance notice.
Tolerance on the given sizes +/- 2%.

MILLER

Design Gianfranco Frigerio

cod. 15442

Elemento Ø70 cm / Element Ø70 cm

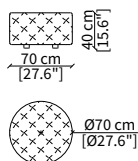

cod. 15443

Elemento Ø70 cm / Element Ø70 cm

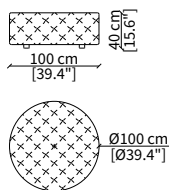

TAVOLINI / SMALL TABLES

cod. 15444

Elemento 80x80 cm / Element 80x80 cm

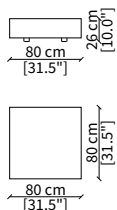

cod. 15445

Elemento 100x100 cm / Element 100x100 cm

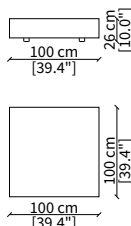

cod. 15446

Elemento 88x40 cm / Element 88x40 cm

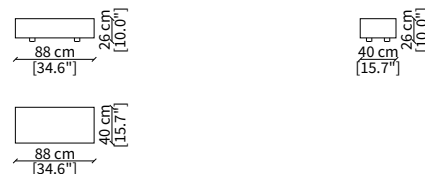

cod. 15447

Elemento 100x40 cm / Element 100x40 cm



cod. 15494

Elemento 143x40 cm / Element 143x40 cm

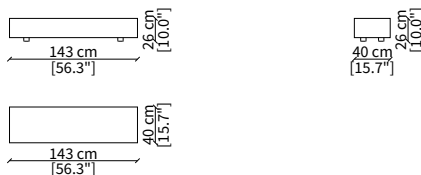

CUSCINI / CUSHIONS

cod. AM

Cuscino 63x28 cm / Cushion 63x28 cm

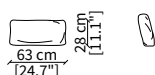

cod. PM

Cuscino 55x53 cm / Cushion 55x53 cm

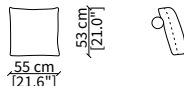

cod. MM

Cuscino 70x53 cm / Cushion 70x53 cm

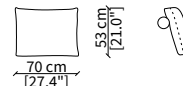

cod. GM

Cuscino 80x53 cm / Cushion 80x53 cm

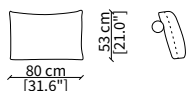

cod. 10424

Cuscino a libero posizionamento 57x53 cm
Freestanding backrest 57x53 cm



cod. 10425

Cuscino a libero posizionamento 78x53 cm
Freestanding backrest 78x53 cm

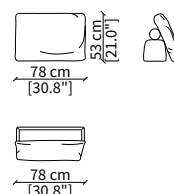

MILLER

Design Gianfranco Frigerio

cod. 15448

Cuscino poggiatesta 60x73,5 cm

Headrest cushion 60x73,5 cm

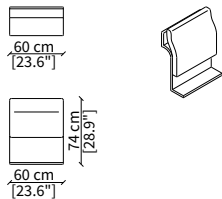

Dimensioni espresse in cm se non diversamente indicato.
L'Azienda si riserva il diritto di apportare modifiche ai modelli senza preavviso.
Tolleranza sulle misure indicate di +/- 2%.

Dimensions in centimeter if not differently indicated.
The Company reserves the right to change the models without any advance notice.
Tolerance on the given sizes +/- 2%.

MILLER TOP

Design Gianfranco Frigerio



Terminali, chaises longue, dormeuses e pouf caratterizzati da struttura con top imbottito e schienale sporgente, che servono da appoggio e contenimento per i loro accessori, che sono privi di piedini e assicurati al top tramite calamite.

Terminals, chaises longues, dormeuses and poufs characterised by a structure with upholstered top and longer backrest, used to support and contain their accessories, which are without feet and secured to the top by magnets.

VOLUME SOFT



15590



15532



15533



15534

Elemento TOP con volume SOFT.
Volume SOFT, elemento imbottito e trapuntato.

*Element TOP with volume SOFT.
Volume SOFT, padded and quilted element.*

VOLUME PAD



15592



15535



15536



15537

Elemento TOP con volume PAD.
Volume PAD, elemento disponibile in gres porcellanato effetto marmo, rivestito in cuoio oppure impiallacciato nelle finiture della collezione Frigerio.

*Element TOP with volume PAD.
Volume PAD, element available in gres porcelain marble effect, in hide leather or veneered in the finishes of the Frigerio collection.*

CABINET



15593



15541



15542



15543

Elemento TOP con volume CABINET.
Volume CABINET, elemento disponibile in finitura impiallacciata nelle finiture della collezione Frigerio.

*Element TOP with volume CABINET.
Volume CABINET, element available veneered in the finishes of the Frigerio collection.*



POUFS TOP



15592



15593



15590

TERMINALI TOP

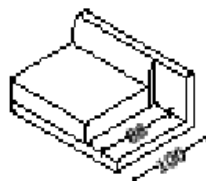

15535



15541



15532

POUFS TOP



15536



15542



15533

CHAISE LONGUE TOP

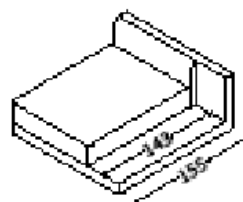

15537



15543



15534

LONGUES TOP

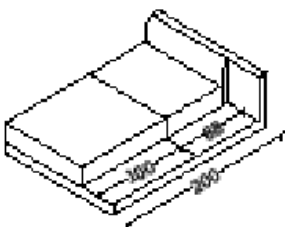

15535



15541



15532



15536



15542



15533

MILLER TOP

Design Gianfranco Frigerio

ELEMENTI TERMINALI TOP / TERMINAL TOP ELEMENTS

cod. 15800

Terminale PLAIN 120 cm / Terminal PLAIN 120 cm

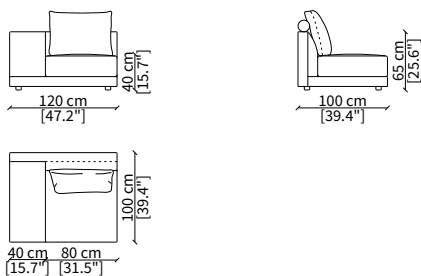

cod. 15500

Elemento QUILT 80 cm / Element QUILT 80 cm

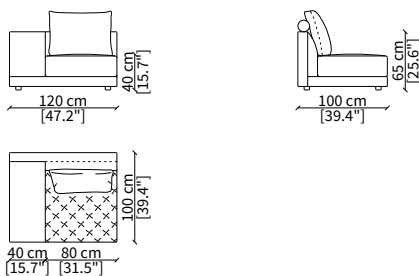

cod. 15801

Elemento PLAIN 130 cm / Element PLAIN 130 cm

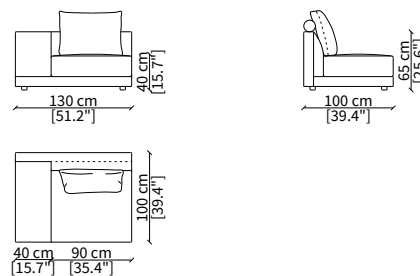

cod. 15501

Elemento QUILT 130 cm / Element QUILT 130 cm

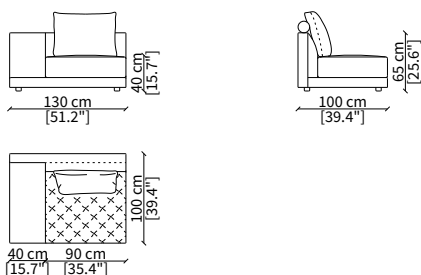

cod. 15802

Elemento PLAIN 140 cm / Element PLAIN 140 cm

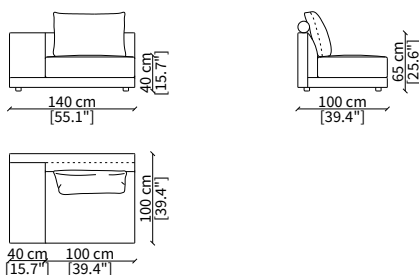

cod. 15502

Elemento QUILT 140 cm / Element QUILT 140 cm

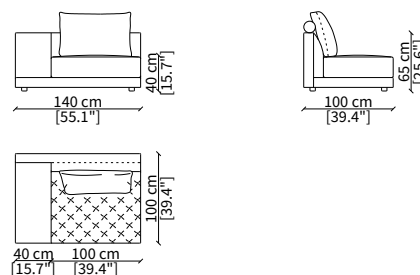

cod. 15803

Elemento PLAIN 150 cm / Element PLAIN 150 cm

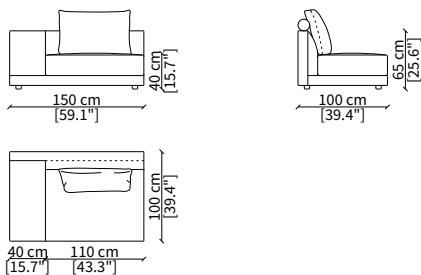

cod. 15503

Elemento QUILT 150 cm / Element QUILT 150 cm

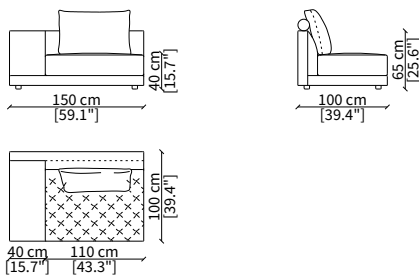

cod. 15804

Elemento PLAIN 160 cm / Element PLAIN 160 cm

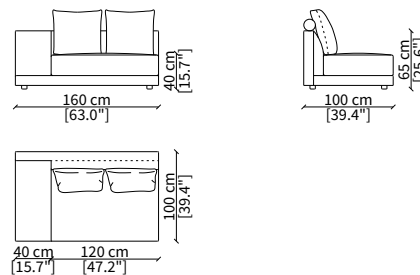

cod. 15504

Elemento QUILT 160 cm / Element QUILT 160 cm

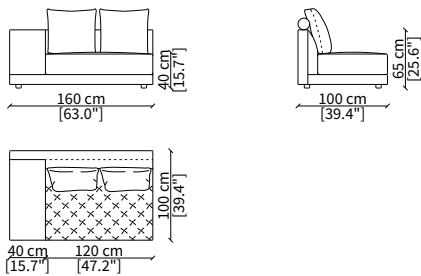

cod. 15805

Elemento PLAIN 180 cm / Element PLAIN 180 cm

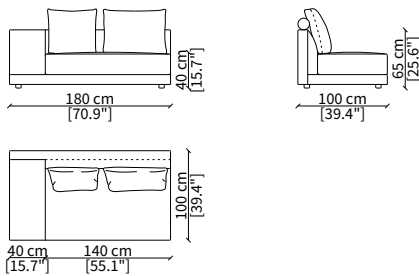

cod. 15505

Elemento QUILT 180 cm / Element QUILT 180 cm

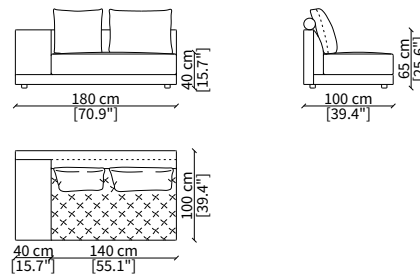

Dimensioni espresse in cm se non diversamente indicato.
L'Azienda si riserva il diritto di apportare modifiche ai modelli senza preavviso.
Tolleranza sulle misure indicate di +/- 2%.

Dimensions in centimeter if not differently indicated.
The Company reserves the right to change the models without any advance notice.
Tolerance on the given sizes +/- 2%.

MILLER TOP

Design Gianfranco Frigerio

ELEMENTI DORMEUSE TOP / DORMEUSE TOP ELEMENTS

cod. 15808

Elemento PLAIN 240 cm / Element PLAIN 240 cm

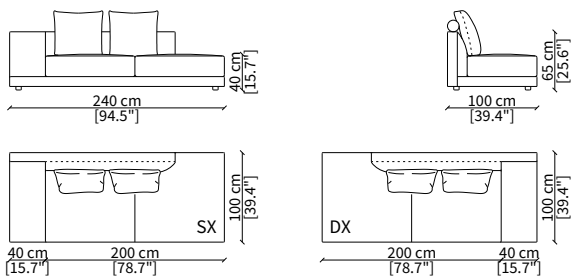

cod. 15508

Elemento QUILT 240 cm / Element QUILT 240 cm

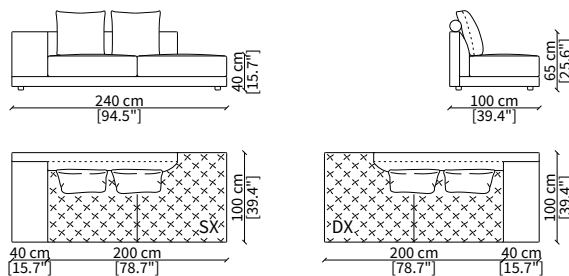

ELEMENTI DORMEUSE POUF TOP / DORMEUSE POUF TOP ELEMENTS

cod. 15809

Elemento PLAIN 280 cm / Element PLAIN 280 cm

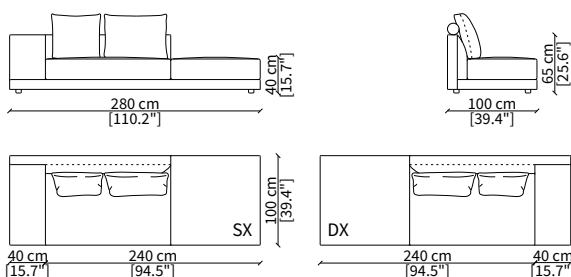

cod. 15509

Elemento QUILT 280 cm / Element QUILT 280 cm

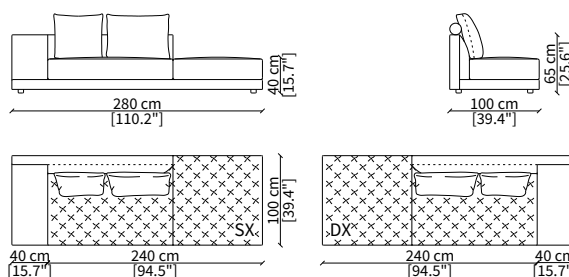

cod. 15600

Elemento QUILTED POUF 280 cm / Element QUILTED POUF 280 cm

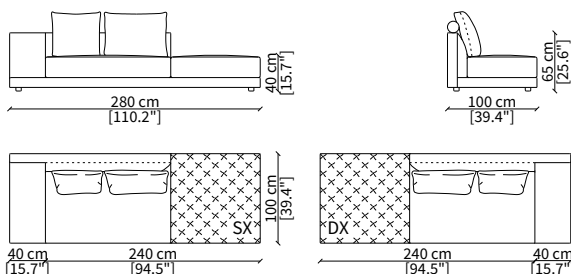

ELEMENTI CHAISE LONGUE TOP / CHAISE LONGUE TOP ELEMENTS

cod. 15806

Elemento PLAIN 140 cm / Element PLAIN 140 cm

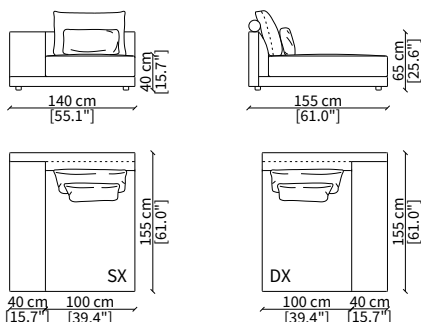

cod. 15506

Elemento QUILT 140 cm / Element QUILT 140 cm

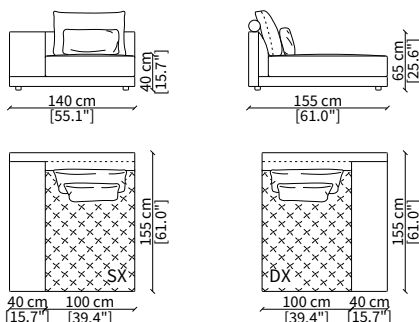

cod. 15807

Elemento PLAIN 160 cm / Element PLAIN 160 cm

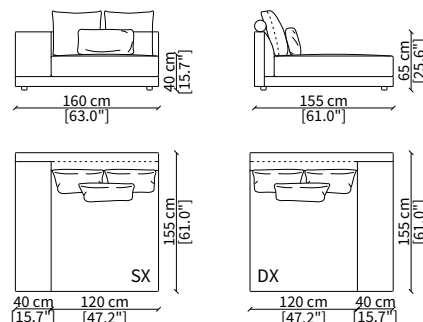

Dimensioni espresse in cm se non diversamente indicato.
L'Azienda si riserva il diritto di apportare modifiche ai modelli senza preavviso.
Tolleranza sulle misure indicate di +/- 2%.

Dimensions in centimeter if not differently indicated.
The Company reserves the right to change the models without any advance notice.
Tolerance on the given sizes +/- 2%.

MILLER TOP

Design Gianfranco Frigerio

cod. 15507

Elemento QUILT 160 cm / Element QUILT 160 cm

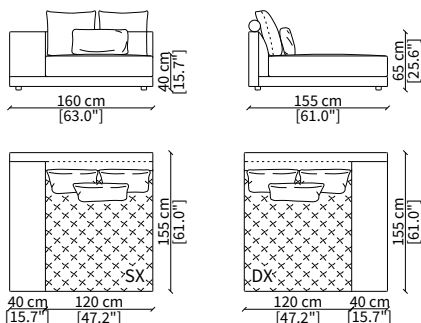

ELEMENTI LONGUE TOP / LONGUE TOP ELEMENTS

cod. 15888

Elemento PLAIN 120 cm / Element PLAIN 120 cm

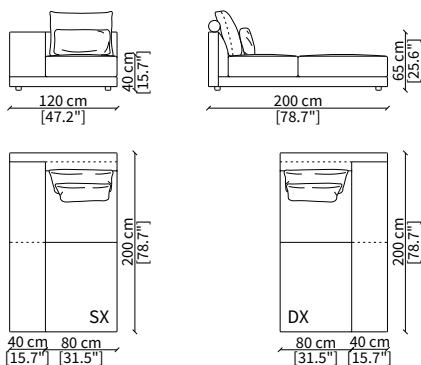

cod. 15588

Elemento QUILT 120 cm / Element QUILT 120 cm

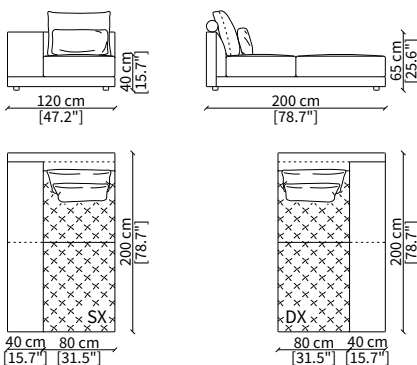

cod. 15601

Elemento una seduta QUILT 120 cm / Element one seat QUILT 120 cm

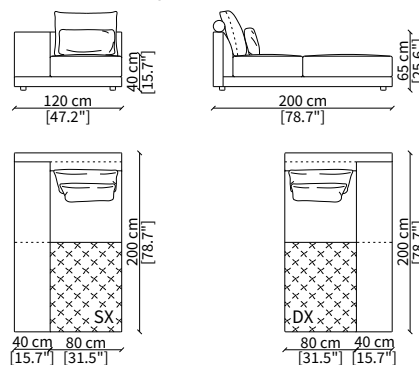

cod. 15810

Elemento PLAIN 140 cm / Element PLAIN 140 cm

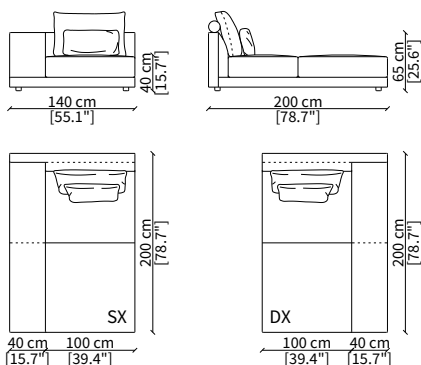

cod. 15510

Elemento QUILT 140 cm / Element QUILT 140 cm

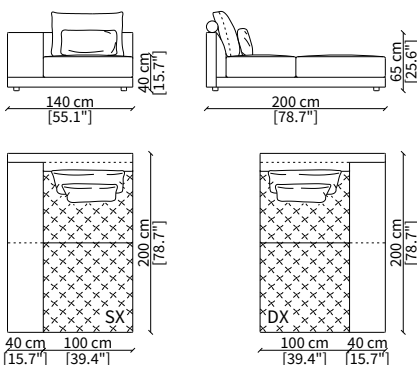

cod. 15602

Elemento una seduta QUILT 140 cm / Element one seat QUILT 140 cm

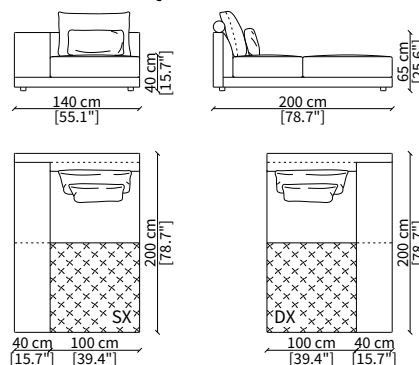

Dimensioni espresse in cm se non diversamente indicato.
L'Azienda si riserva il diritto di apportare modifiche ai modelli senza preavviso.
Tolleranza sulle misure indicate di +/- 2%.

Dimensions in centimeter if not differently indicated.
The Company reserves the right to change the models without any advance notice.
Tolerance on the given sizes +/- 2%.

MILLER TOP

Design Gianfranco Frigerio

cod. 15811

Elemento PLAIN 100 cm / Element PLAIN 100 cm

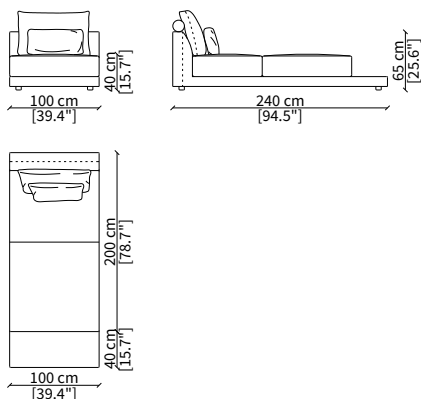

cod. 15511

Elemento QUILT 100 cm / Element QUILT 100 cm

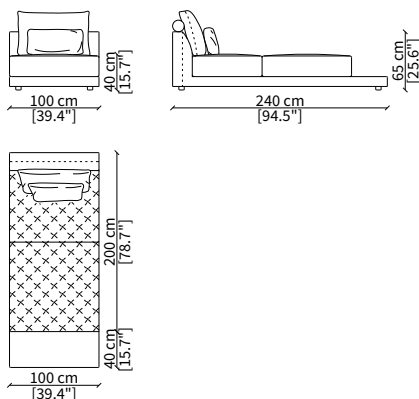

cod. 15603

Elemento una seduta QUILT 100 cm
Element one seat QUILT 100 cm

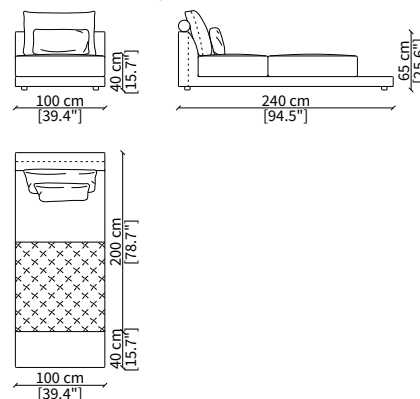

POUF TOP

cod. 15898

Elemento PLAIN 120 cm / Element PLAIN 120 cm

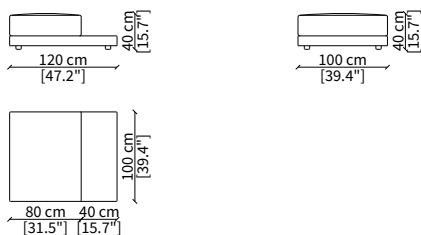

cod. 15598

Elemento QUILT 120 cm / Element QUILT 120 cm

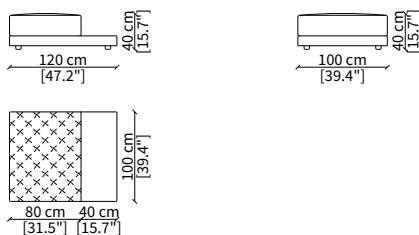

cod. 15822

Elemento PLAIN 140 cm / Element PLAIN 140 cm

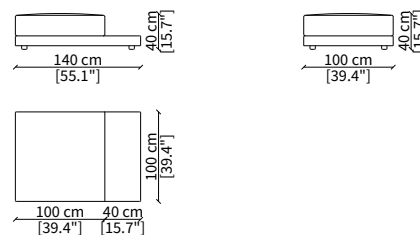

cod. 15522

Elemento QUILT 140 cm / Element QUILT 140 cm

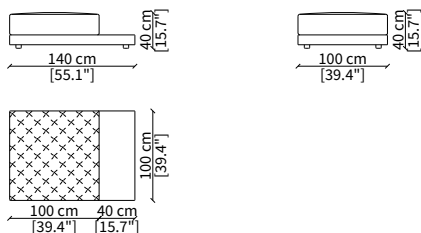

cod. 15824B

Elemento PLAIN 200 cm / Element PLAIN 200 cm

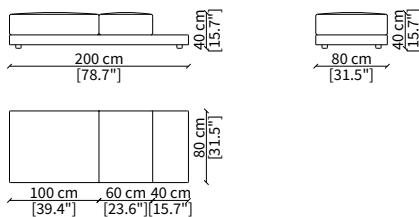

cod. 15524B

Elemento QUILT 200 cm / Element QUILT 200 cm

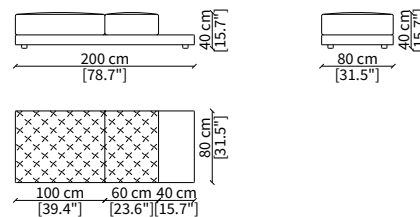

Dimensioni espresse in cm se non diversamente indicato.
L'Azienda si riserva il diritto di apportare modifiche ai modelli senza preavviso.
Tolleranza sulle misure indicate di +/- 2%.

Dimensions in centimeter if not differently indicated.
The Company reserves the right to change the models without any advance notice.
Tolerance on the given sizes +/- 2%.

MILLER TOP

Design Gianfranco Frigerio

cod. 15823B

Elemento PLAIN 200 cm / Element PLAIN 200 cm

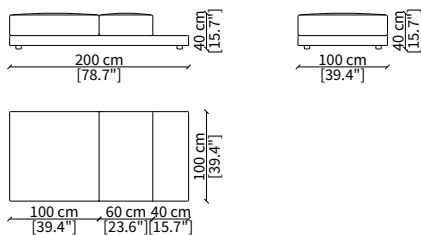

cod. 15523B

Elemento QUILT 200 cm / Element QUILT 200 cm

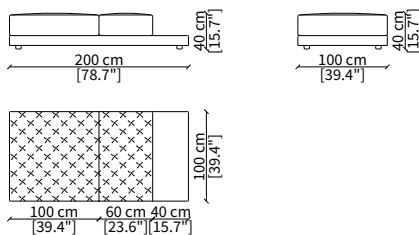

cod. 15824A

Elemento PLAIN 200 cm / Element PLAIN 200 cm

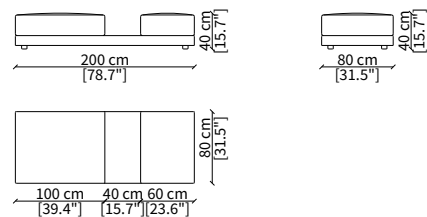

cod. 15524A

Elemento QUILT 200 cm / Element QUILT 200 cm

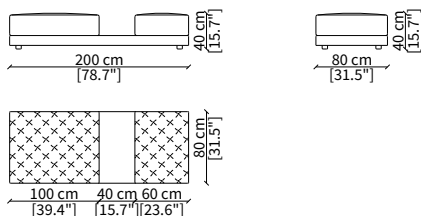

cod. 15823A

Elemento PLAIN 200 cm / Element PLAIN 200 cm

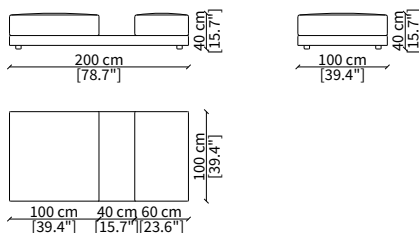

cod. 15523A

Elemento QUILT 200 cm / Element QUILT 200 cm

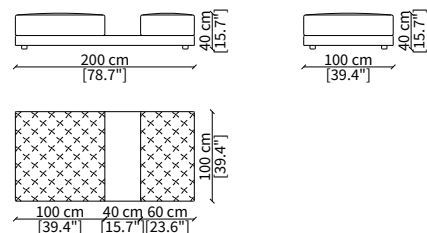

VOLUME SOFT

cod. 15590

Elemento QUILT 80 cm / Element QUILT 80 cm

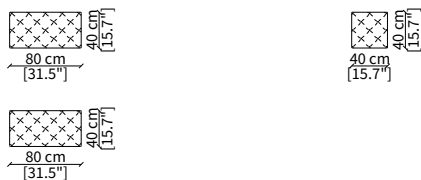

cod. 15532

Elemento QUILT 88 cm / Element QUILT 88 cm

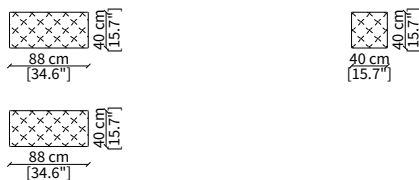

cod. 15533

Elemento QUILT 100 cm / Element QUILT 100 cm



cod. 15534

Elemento QUILT 143 cm / Element QUILT 143 cm

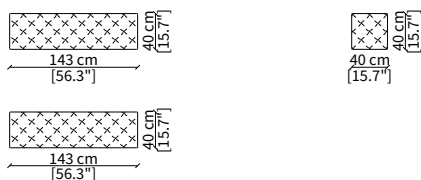

Dimensioni espresse in cm se non diversamente indicato.
L'Azienda si riserva il diritto di apportare modifiche ai modelli senza preavviso.
Tolleranza sulle misure indicate di +/- 2%.

Dimensions in centimeter if not differently indicated.
The Company reserves the right to change the models without any advance notice.
Tolerance on the given sizes +/- 2%.

MILLER TOP

Design Gianfranco Frigerio

VOLUME PAD

cod. 15592

Elemento 80 cm / Element 80 cm

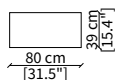
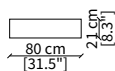

cod. 15535

Elemento 88 cm / Element 88 cm

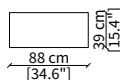
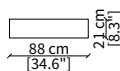

cod. 15536

Elemento 100 cm / Element 100 cm

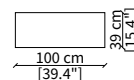
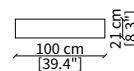

cod. 15537

Elemento 143 cm / Element 143 cm

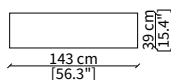
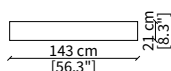

CABINET

cod. 15593

Elemento 80 cm / Element 80 cm

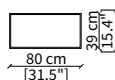
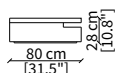

cod. 15541

Elemento 88 cm / Element 88 cm

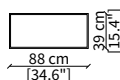
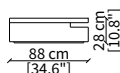

cod. 15542

Elemento 100 cm / Element 100 cm

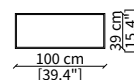
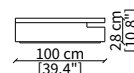

cod. 15543

Elemento 143 cm / Element 143 cm

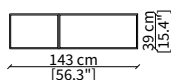
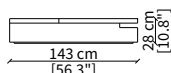

Dimensioni espresse in cm se non diversamente indicato.
L'Azienda si riserva il diritto di apportare modifiche ai modelli senza preavviso.
Tolleranza sulle misure indicate di +/- 2%.

Dimensions in centimeter if not differently indicated.
The Company reserves the right to change the models without any advance notice.
Tolerance on the given sizes +/- 2%.

MILLER

Design Gianfranco Frigerio

CUSCINI / CUSHIONS

cod. AM

Cuscino 63x28 cm / Cushion 63x28 cm

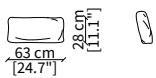

cod. PM

Cuscino 55x53 cm / Cushion 55x53 cm

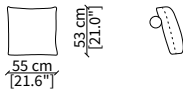

cod. MM

Cuscino 70x53 cm / Cushion 70x53 cm

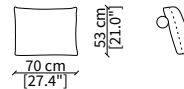

cod. GM

Cuscino 80x53 cm / Cushion 80x53 cm

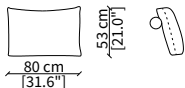

cod. 10424

Cuscino a libero posizionamento 57x53 cm
Freestanding backrest 57x53 cm

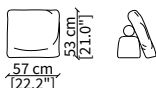

cod. 10425

Cuscino a libero posizionamento 78x53 cm
Freestanding backrest 78x53 cm

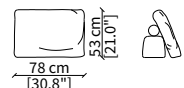

cod. 15448

Cuscino poggiatesta 60x73,5 cm
Headrest cushion 60x73,5 cm

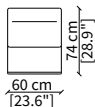

MILLER OPEN

Design Gianfranco Frigerio



Terminali, chaises longue e dormeuses caratterizzati da struttura con schienale sporgente, che serve da contenimento per gli accessori.

Terminals, chaises longues and dormeuses characterised by a structure with longer backrest, used to contain their accessories.

DAY LOW



15526

Elemento OPEN bracciolo DAY LOW.

Bracciolo DAY LOW con parte trapuntata in tessuto o pelle e parte libreria in impiallacciato nelle finiture della collezione Frigerio. Basamento in metallo color brunito.



15527



15528

Element OPEN armrest DAY LOW. Armrest DAY LOW with quilted part in fabric or leather and bookcase part veneered in the finishes of the Frigerio collection. Base in metal burnished colour.

WOOD



15526

Elemento OPEN bracciolo WOOD.

Bracciolo WOOD impiallacciato nelle finiture della collezione Frigerio. Basamento in metallo color brunito.



15527



15528

Element OPEN armrest WOOD. Armrest WOOD veneered in the finishes of the Frigerio collection. Base in metal burnished colour.

MILLER OPEN

Design Gianfranco Frigerio



TERMINALI OPEN

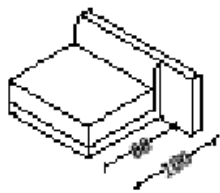

15526



15538

CHAISE LONGUE OPEN

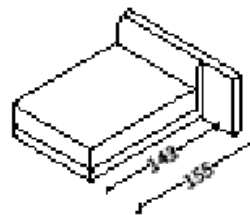

15528



15540

LONGUES OPEN

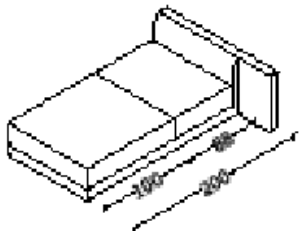

15526



15538



15527



15539

MILLER OPEN

Design Gianfranco Frigerio

ELEMENTI TERMINALI OPEN / TERMINAL OPEN ELEMENTS

cod. 15812

Terminale PLAIN 120 cm / Terminal PLAIN 120 cm

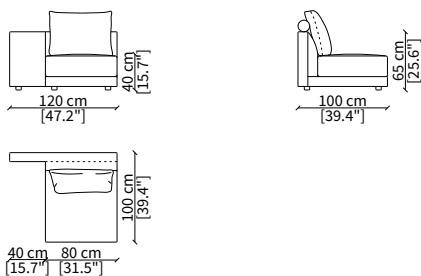

cod. 15512

Elemento QUILT 80 cm / Element QUILT 80 cm

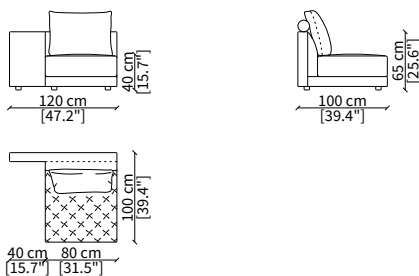

cod. 15813

Elemento PLAIN 130 cm / Element PLAIN 130 cm

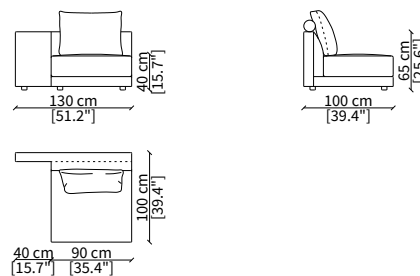

cod. 15513

Elemento QUILT 130 cm / Element QUILT 130 cm

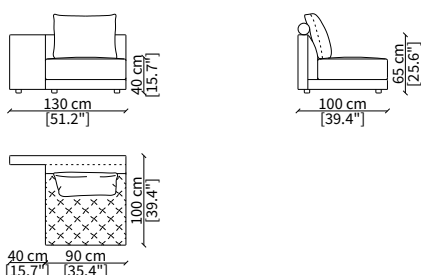

cod. 15814

Elemento PLAIN 140 cm / Element PLAIN 140 cm

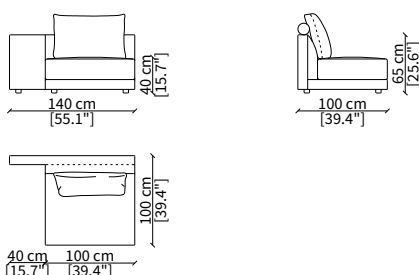

cod. 15514

Elemento QUILT 140 cm / Element QUILT 140 cm

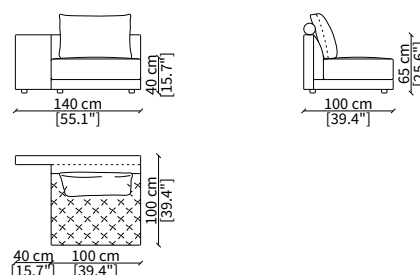

cod. 15815

Elemento PLAIN 150 cm / Element PLAIN 150 cm

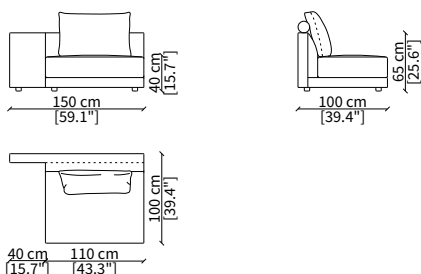

cod. 15515

Elemento QUILT 150 cm / Element QUILT 150 cm

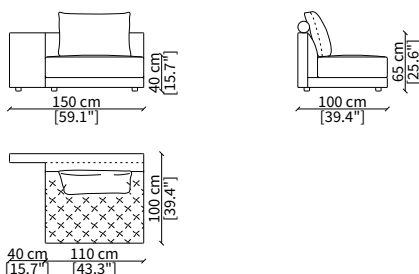

cod. 15816

Elemento PLAIN 160 cm / Element PLAIN 160 cm

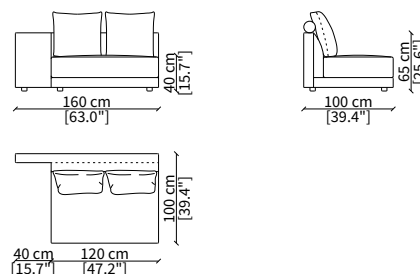

cod. 15516

Elemento QUILT 160 cm / Element QUILT 160 cm

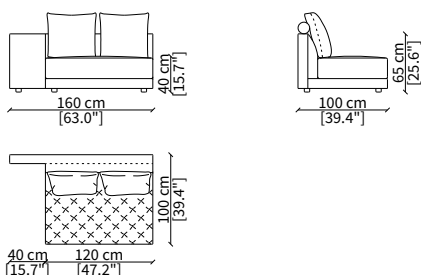

cod. 15817

Elemento PLAIN 180 cm / Element PLAIN 180 cm

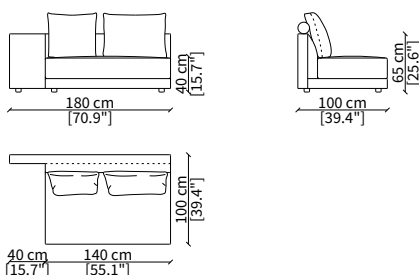

cod. 15517

Elemento QUILT 180 cm / Element QUILT 180 cm

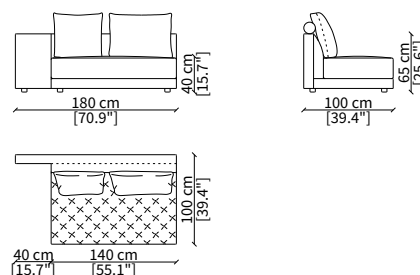

Dimensioni espresse in cm se non diversamente indicato.
L'Azienda si riserva il diritto di apportare modifiche ai modelli senza preavviso.
Tolleranza sulle misure indicate di +/- 2%.

Dimensions in centimeter if not differently indicated.
The Company reserves the right to change the models without any advance notice.
Tolerance on the given sizes +/- 2%.

MILLER OPEN

Design Gianfranco Frigerio

ELEMENTI DORMEUSE OPEN / DORMEUSE OPEN ELEMENTS

cod. 15820

Elemento PLAIN 240 cm / Element PLAIN 240 cm

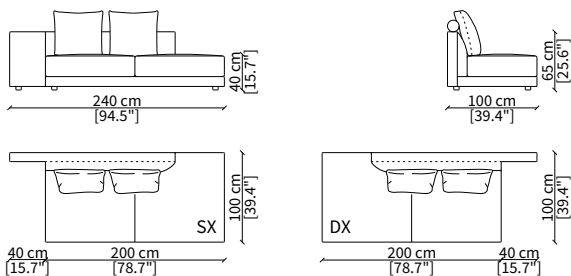

cod. 15520

Elemento QUILT 240 cm / Element QUILT 240 cm

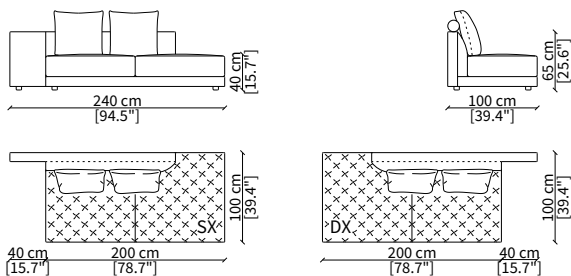

ELEMENTI DORMEUSE POUF OPEN / DORMEUSE POUF OPEN ELEMENTS

cod. 15821

Elemento PLAIN 280 cm / Element PLAIN 280 cm

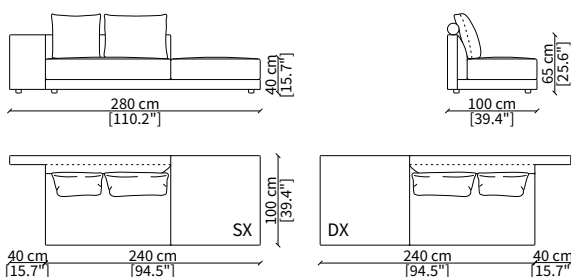

cod. 15521

Elemento QUILT 280 cm / Element QUILT 280 cm

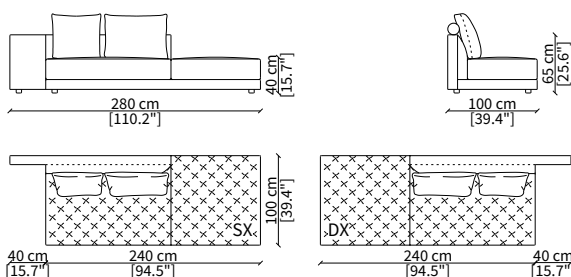

cod. 15604

Elemento QUILTED POUF 280 cm / Element QUILTED POUF 280 cm

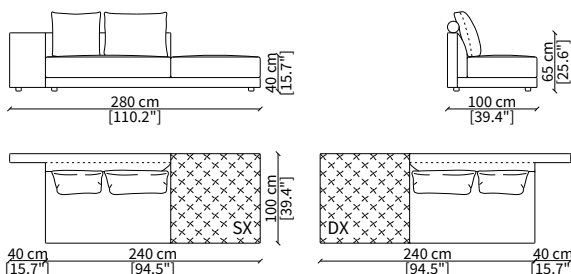

ELEMENTI CHAISE LONGUE OPEN / CHAISE LONGUE POUF OPEN ELEMENTS

cod. 15818

Elemento PLAIN 140 cm / Element PLAIN 140 cm

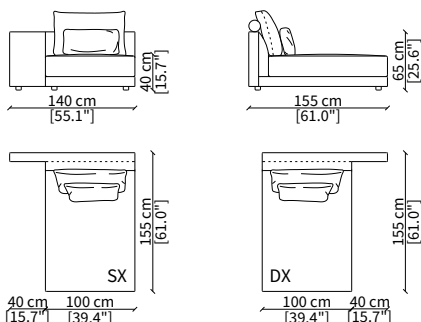

cod. 15518

Elemento QUILT 140 cm / Element QUILT 140 cm

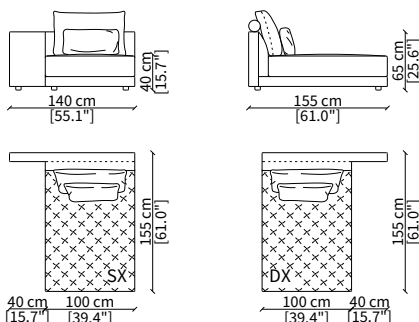

cod. 15819

Elemento PLAIN 160 cm / Element PLAIN 160 cm

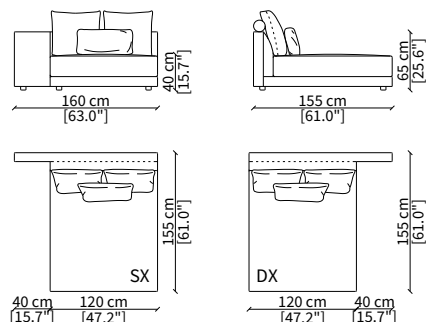

Dimensioni espresse in cm se non diversamente indicato.
L'Azienda si riserva il diritto di apportare modifiche ai modelli senza preavviso.
Tolleranza sulle misure indicate di +/- 2%.

Dimensions in centimeter if not differently indicated.
The Company reserves the right to change the models without any advance notice.
Tolerance on the given sizes +/- 2%.

MILLER OPEN

Design Gianfranco Frigerio

cod. 15519

Elemento QUILT 160 cm / Element QUILT 160 cm

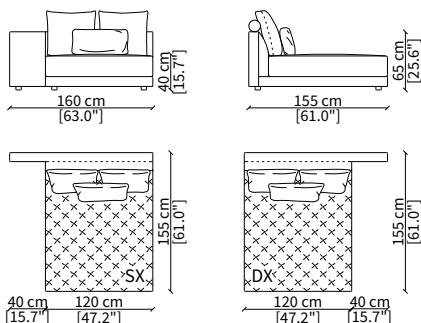

ELEMENTI LONGUE OPEN / LONGUE OPEN ELEMENTS

cod. 15894

Elemento PLAIN 120 cm / Element PLAIN 120 cm

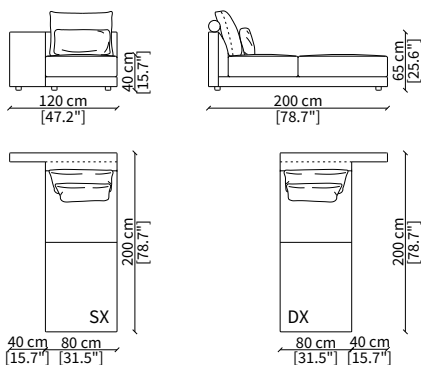

cod. 15594

Elemento QUILT 120 cm / Element QUILT 120 cm

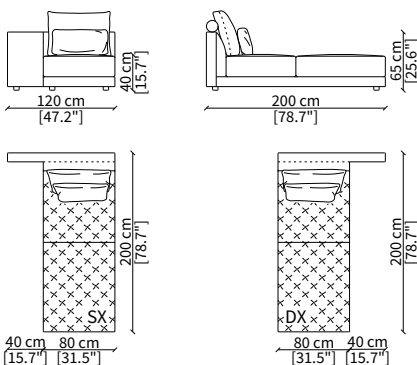

cod. 15605

Elemento una seduta QUILT 120 cm / Element one seat QUILT 120 cm

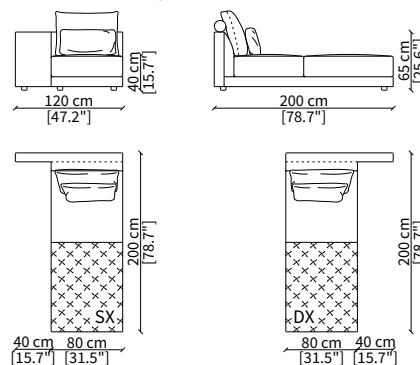

cod. 15849

Elemento PLAIN 140 cm / Element PLAIN 140 cm

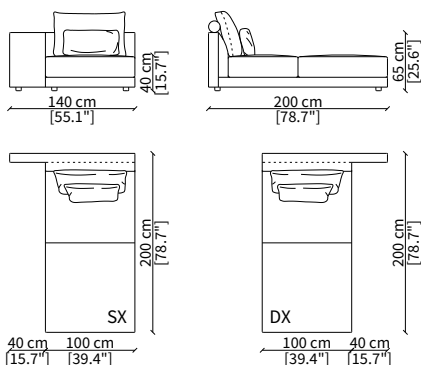

cod. 15549

Elemento QUILT 140 cm / Element QUILT 140 cm

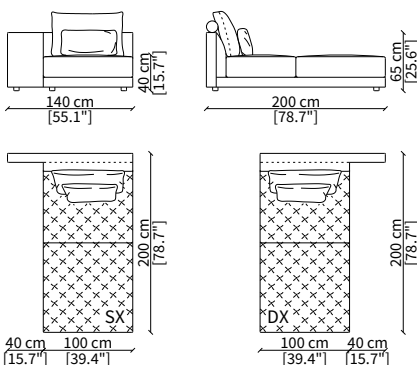

cod. 15606

Elemento una seduta QUILT 140 cm / Element one seat QUILT 140 cm

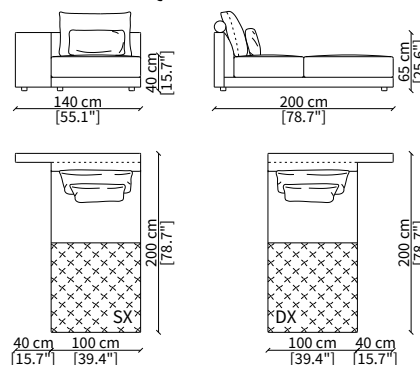

Dimensioni espresse in cm se non diversamente indicato.
L'Azienda si riserva il diritto di apportare modifiche ai modelli senza preavviso.
Tolleranza sulle misure indicate di +/- 2%.

Dimensions in centimeter if not differently indicated.
The Company reserves the right to change the models without any advance notice.
Tolerance on the given sizes +/- 2%.

MILLER OPEN

Design Gianfranco Frigerio

BRACCIOLI / ARMRESTS

cod. 15526

Bracciolo DAY LOW 88 cm / Armrest DAY LOW 88 cm

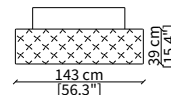
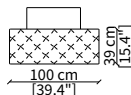
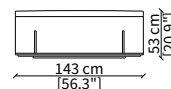
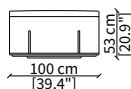
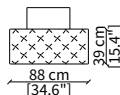
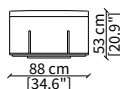

cod. 15538

Bracciolo WOOD 88 cm / Armrest WOOD 88 cm

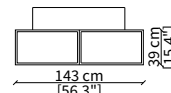
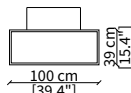
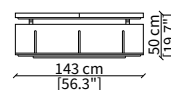
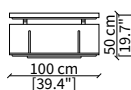
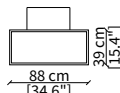
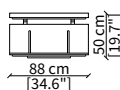

CUSCINI / CUSHIONS

cod. AM

Cuscino 63x28 cm / Cushion 63x28 cm

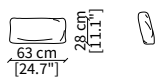

cod. PM

Cuscino 55x53 cm / Cushion 55x53 cm

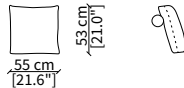

cod. MM

Cuscino 70x53 cm / Cushion 70x53 cm

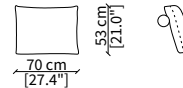

cod. GM

Cuscino 80x53 cm / Cushion 80x53 cm

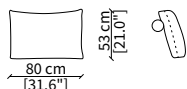

cod. 10424

Cuscino a libero posizionamento 57x53 cm
Freestanding backrest 57x53 cm

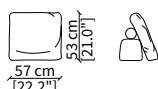

cod. 10425

Cuscino a libero posizionamento 78x53 cm
Freestanding backrest 78x53 cm

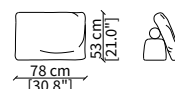

cod. 15448

Cuscino poggiatesta 60x73,5 cm
Headrest cushion 60x73,5 cm

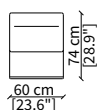

Dimensioni espresse in cm se non diversamente indicato.
L'Azienda si riserva il diritto di apportare modifiche ai modelli senza preavviso.
Tolleranza sulle misure indicate di +/- 2%.

Dimensions in centimeter if not differently indicated.
The Company reserves the right to change the models without any advance notice.
Tolerance on the given sizes +/- 2%.

MILLER

Design Gianfranco Frigerio

ESEMPI DI COMBINAZIONI / COMBINATION EXAMPLES

cod. 15700

divano 180 cm cod. 15700

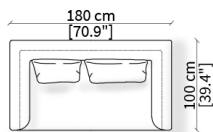

cod. 15715

terminale 120 cm cod. 15715

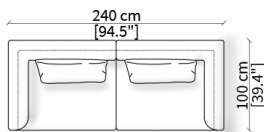

cod. 15718 + 15733

terminale 160 cm cod. 15718
dormeuse angolo 220 cm cod. 15733

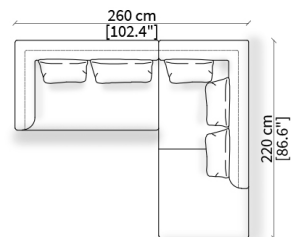

cod. 15718 + 15731

terminale 160 cm cod. 15718
chaise longue angolo 120 cm cod. 15731

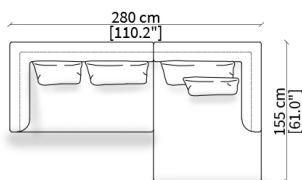

cod. 15715 + 15703 + 15802 + 15822

terminale 120 cm cod. 15715
centrale 100 cm cod. 15703
terminale top 140/100 cm cod. 15802
pouf top 140/100 cm cod. 15822

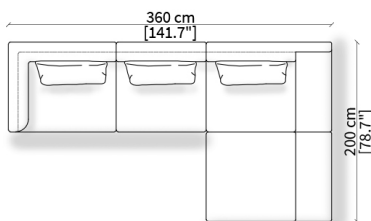

cod. 15715 + 15703 + 15611

terminale 120 cm cod. 15715
centrale 100 cm cod. 15703
dormeuse terminale pouf 260 cm cod. 15611

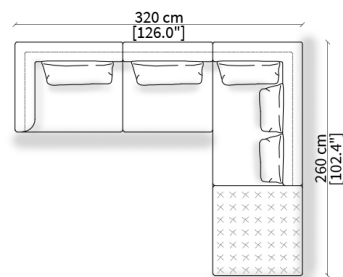

cod. 15800 + 15532 + 15701 + 15825 + 15736

terminale top 120/80 cm cod. 15800
pouf volume 88x40 cm cod. 15532
centrale 80 cm cod. 15701
elemento curvo 142 cm cod. 15825
pouf 100x100 cm cod. 15736

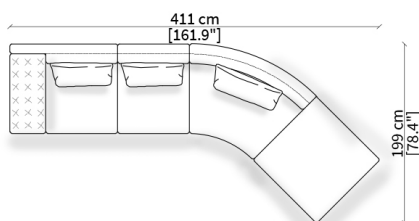

cod. 15436 + 15703 + 15825 + 15814 + 15538

pouf 100x100 cm cod. 15436
centrale 100 cm cod. 15703
elemento curvo 142 cm cod. 15825
terminale open 140/100 cm cod. 15814
wood 88 cm cod. 15538

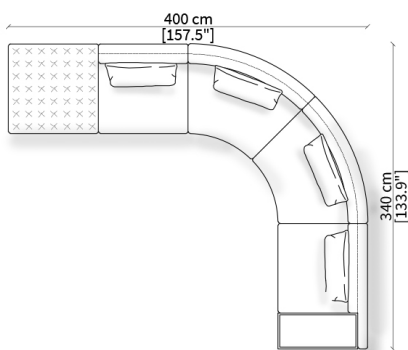

cod. 15817+15526+15522+15703+15814+15538

terminale open 180/140 cm cod. 15817
day low 88 cm cod. 15526
pouf top 140/100 cm cod. 15522
centrale 100 cm cod. 15703
terminale open 140/100 cm cod. 15814
wood 88 cm cod. 15538
pad 100 cm cod. 15536

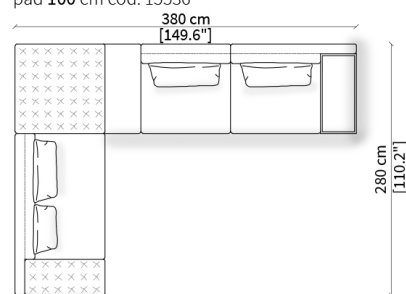

Dimensioni espresse in cm se non diversamente indicato.
L'Azienda si riserva il diritto di apportare modifiche ai modelli senza preavviso.
Tolleranza sulle misure indicate di +/- 2%.

Dimensions in centimeter if not differently indicated.
The Company reserves the right to change the models without any advance notice.
Tolerance on the given sizes +/- 2%.

MILLER

Design Gianfranco Frigerio

TESSUTO / FABRIC



Asolo



Avignone



Bellagio



Butterfly



Caprera



Capri



Caracalla



Chioggia

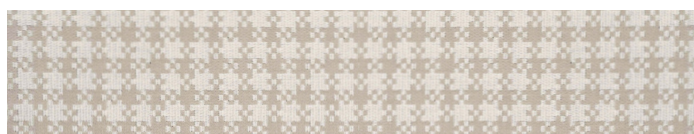

Candotti



Dorian

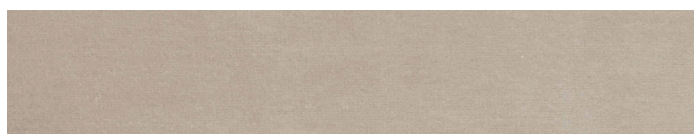

Fiocco



Il Trovatore



Ischia



Katmandu



La Boheme



Lario



Linosa



Maddalena

La presente tabella tessile, pelli e materiali è a solo titolo indicativo e non vincolante. L'effettiva disponibilità di ogni materiale deve essere preventivamente verificata con l'ufficio commerciale Frigerio.

L'azienda si riserva il diritto di sospendere la disponibilità di qualsiasi materiale senza alcun obbligo di preavviso sulla presente scheda tecnica.

I colori visualizzati, per ovvie ragioni tecniche, sono indicativi e possono differire dall'originale. Fare riferimento al listino prezzi per uso e disponibilità di ogni singola finitura.

The above textile, leather and material charts are only indicative and not binding. The actual availability of any material shall be checked in advance with the Frigerio commercial office.

The company reserves the right to discontinue any material without any obligation of due notice on this technical data sheet.

The colours visualized, for obvious technical reasons, are indicative and may differ from the original.

Please refer to price list for use and availability of each finish.

MILLER

Design Gianfranco Frigerio

TESSUTO / FABRIC



Moritz



Nebraska

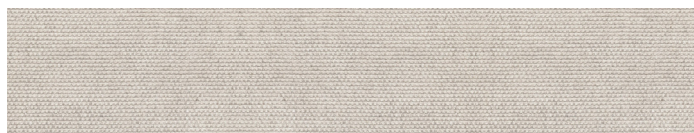

Padova



Panarea



Piazza Di Spagna



Ponza



Porto Cervo



Porto Rotondo

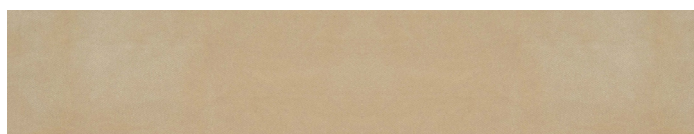

Rem



San Remo

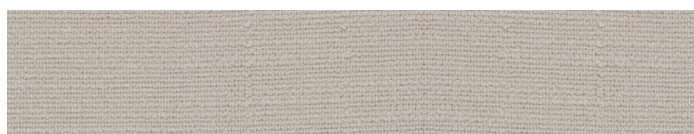

Tellaro



Tenerife

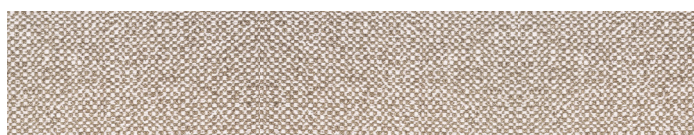

Turandot



Ventotene



Villa Borghese

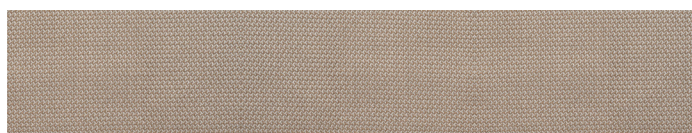

Villa d'Este

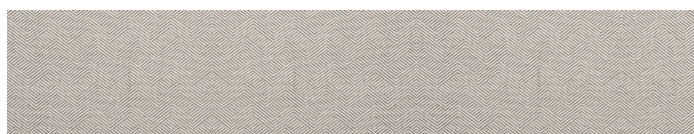

Villa Flori



VF 1650

La presente tabella tessile, pelli e materiali è a solo titolo indicativo e non vincolante. L'effettiva disponibilità di ogni materiale deve essere preventivamente verificata con l'ufficio commerciale Frigerio.

L'azienda si riserva il diritto di sospendere la disponibilità di qualsiasi materiale senza alcun obbligo di preavviso sulla presente scheda tecnica.

I colori visualizzati, per ovvie ragioni tecniche, sono indicativi e possono differire dall'originale. Fare riferimento al listino prezzi per uso e disponibilità di ogni singola finitura.

The above textile, leather and material charts are only indicative and not binding. The actual availability of any material shall be checked in advance with the Frigerio commercial office.

The company reserves the right to discontinue any material without any obligation of due notice on this technical data sheet.

The colours visualized, for obvious technical reasons, are indicative and may differ from the original.

Please refer to price list for use and availability of each finish.

MILLER

Design Gianfranco Frigerio

TESSUTO / FABRIC

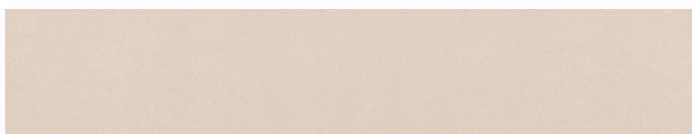

VF 1700



VF 1750



VF 1800

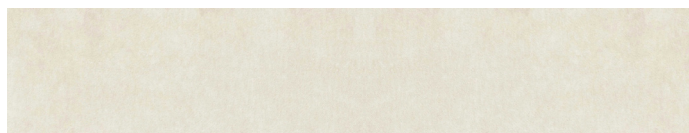

VF 2450



VF 2550

PELLE / LEATHER

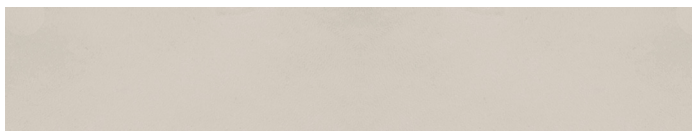

Nubuk

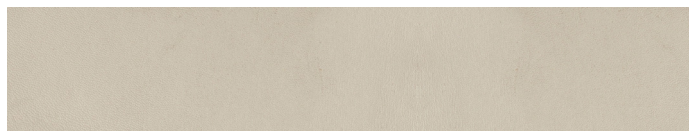

Anilina

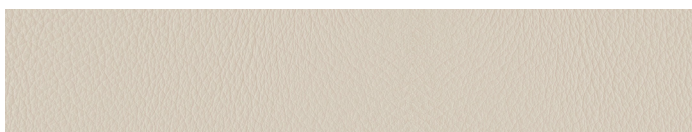

Siena



Bolgheri

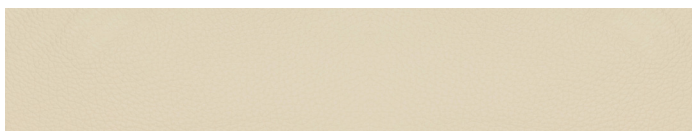

Pisa

La presente tabella tessile, pelli e materiali è a solo titolo indicativo e non vincolante. L'effettiva disponibilità di ogni materiale deve essere preventivamente verificata con l'ufficio commerciale Frigerio.

L'azienda si riserva il diritto di sospendere la disponibilità di qualsiasi materiale senza alcun obbligo di preavviso sulla presente scheda tecnica.

I colori visualizzati, per ovvie ragioni tecniche, sono indicativi e possono differire dall'originale. Fare riferimento al listino prezzi per uso e disponibilità di ogni singola finitura.

The above textile, leather and material charts are only indicative and not binding. The actual availability of any material shall be checked in advance with the Frigerio commercial office.

The company reserves the right to discontinue any material without any obligation of due notice on this technical data sheet.

The colours visualized, for obvious technical reasons, are indicative and may differ from the original.

Please refer to price list for use and availability of each finish.

MILLER

Design Gianfranco Frigerio

CUOIO / HIDE LEATHER

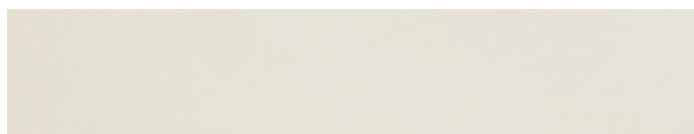

COL. 03

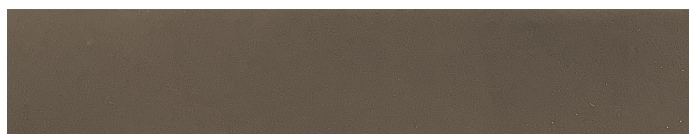

Col. 04

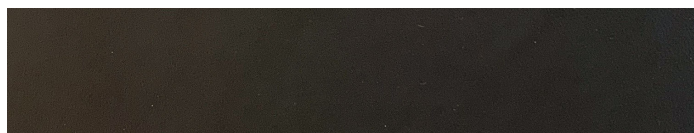

SienaCol. 08



Col. 12

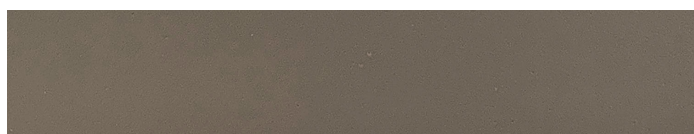

Col. 18

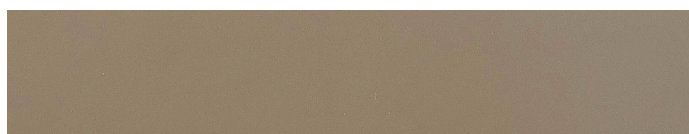

Col. 20

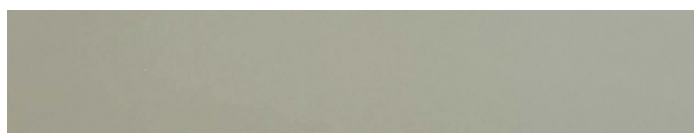

Col. 24

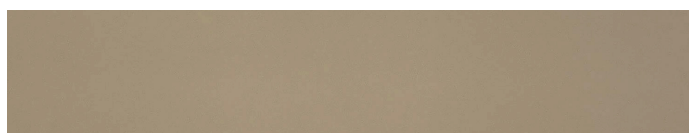

Col. 28



Col. 30

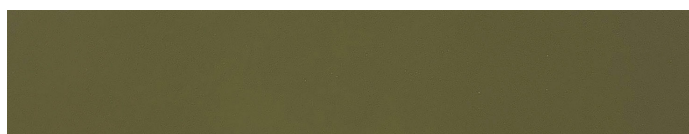

Col. 32

ESSENZE / WOOD



Noce Canaletto
Walnut Canaletto



Frassino Sabbia
Ashwood Sand

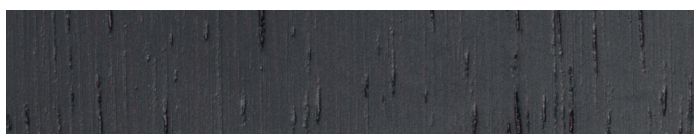

Frassino Wengè
Ashwood Wengè

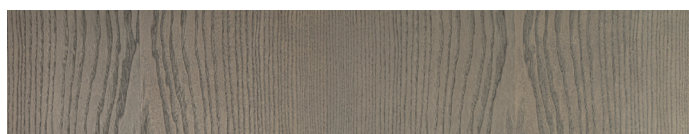

Frassino Greige
Ashwood Greige

La presente tabella tessile, pelli e materiali è a solo titolo indicativo e non vincolante. L'effettiva disponibilità di ogni materiale deve essere preventivamente verificata con l'ufficio commerciale Frigerio.

L'azienda si riserva il diritto di sospendere la disponibilità di qualsiasi materiale senza alcun obbligo di preavviso sulla presente scheda tecnica.

I colori visualizzati, per ovvie ragioni tecniche, sono indicativi e possono differire dall'originale. Fare riferimento al listino prezzi per uso e disponibilità di ogni singola finitura.

The above textile, leather and material charts are only indicative and not binding. The actual availability of any material shall be checked in advance with the Frigerio commercial office.

The company reserves the right to discontinue any material without any obligation of due notice on this technical data sheet.

The colours visualized, for obvious technical reasons, are indicative and may differ from the original.

Please refer to price list for use and availability of each finish.

MILLER

Design Gianfranco Frigerio

TOP

Gres effetto marmo / Porcelain stoneware marble effect



Bright Onyx Lucido
Glossy Bright Onyx



Gold Onyx Lucido
Glossy Gold Onyx



Glam Bronze Lucido
Glossy Glam Bronze

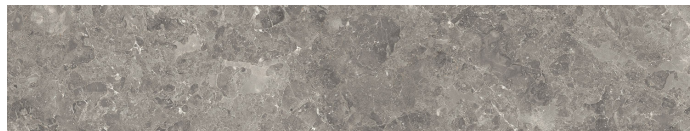

Mineral Grey Opaco
Matt Mineral Grey

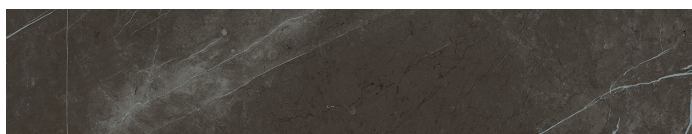

Pietra Grey Lucido
Glossy Pietra Grey

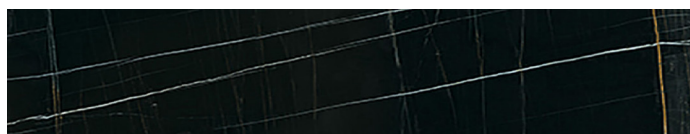

Deep Noir Lucido
Glossy Deep Noir



Saint Laurent Lucido
Glossy Saint Laurent

METALLI / METALS

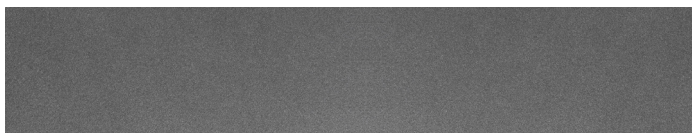

Color Brunito
Burnished Colour

PIEDINI / FEET



Color Nero
Black Colour

PROFILO / PIPING

Per il profilo tono su tono fare riferimento alla gamma tessile Frigerio.
Per il profilo in contrasto, disponibile solo in Grosgrain, fare riferimento al listino prezzi e alla pagina del sito dedicata.

For piping tone on tone please refer to the textile range of Frigerio.
For piping in contrast, available only in Grosgrain, please refer to the price list and the dedicated landing page in our website.

La presente tabella tessile, pelli e materiali è a solo titolo indicativo e non vincolante. L'effettiva disponibilità di ogni materiale deve essere preventivamente verificata con l'ufficio commerciale Frigerio.

*L'azienda si riserva il diritto di sospendere la disponibilità di qualsiasi materiale senza alcun obbligo di preavviso sulla presente scheda tecnica.
I colori visualizzati, per ovvie ragioni tecniche, sono indicativi e possono differire dall'originale.
Fare riferimento al listino prezzi per uso e disponibilità di ogni singola finitura.*

*The above textile, leather and material charts are only indicative and not binding. The actual availability of any material shall be checked in advance with the Frigerio commercial office.
The company reserves the right to discontinue any material without any obligation of due notice on this technical data sheet.*

*The colours visualized, for obvious technical reasons, are indicative and may differ from the original.
Please refer to price list for use and availability of each finish.*