

Collection BRIO

rochebobois
PARIS

design Sacha LAKIC



PO090

Collection BRIO

rochebobois
PARIS

design Sacha LAKIC



Chaise - Chair - Sedia - Silla - Stuhl

Bridge - Armchair - Poltrona - Sillón - Armlehnstuhl

Collection BRIO

rochebobois
PARIS

design Sacha LAKIC

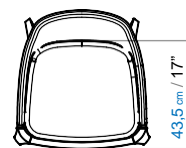
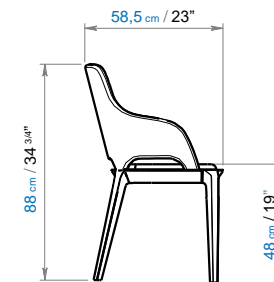
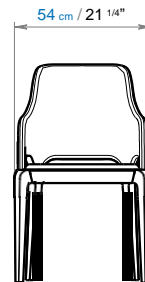
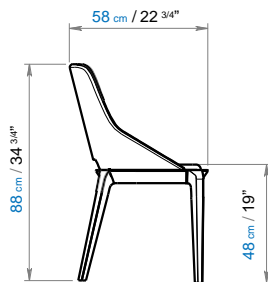
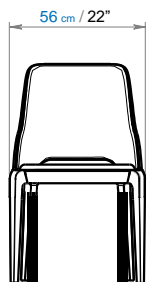

Chaise: L 56 x H 88 x P 58 cm - L 22" x H 34 3/4" x P 22 3/4"
Pieds en hêtre - coque rembourrée, recouverte en cuir ou tissu.

Chair: L 56 x H 88 x P 58 cm - L 22" x H 34 3/4" x P 22 3/4"
Beech legs - upholstered shell in leather or fabric.

Sedia: L 56 x H 88 x P 58 cm - L 22" x H 34 3/4" x P 22 3/4"
Gambe in faggio - scocca imbottita in pelle o tessuto.

Silla: L 56 x H 88 x P 58 cm - L 22" x H 34 3/4" x P 22 3/4"
Patatas de haya - tapizada en cuero o tela.

Bridge: L 54 x H 88 x P 58,5 cm - L 21 1/4" x H 34 3/4" x P 23"
Pieds en hêtre - coque rembourrée recouverte en cuir ou tissu.

Armchair: L 56 x H 88 x P 58 cm - L 22" x H 34 3/4" x P 22 3/4"
Beech legs - upholstered shell in leather or fabric.

Poltrona: L 54 x H 88 x P 58,5 cm - L 21 1/4" x H 34 3/4" x P 23"
Gambe in faggio - scocca imbottita in pelle o tessuto.

Sillón: L 54 x H 88 x P 58,5 cm - L 21 1/4" x H 34 3/4" x P 23"
Patatas de haya - tapizada en cuero o tela.



Ce produit est certifié FSC™ mixte, composé de matériaux provenant de forêts certifiées FSC™ gérées de façon responsable et d'autres sources contrôlées. Le choix de ce produit participe à la préservation des forêts et de la biodiversité.

This product is certified as FSC™ mix, composed of materials from responsibly managed forest and other controlled sources. The choice of this model contributes to the preservation of forests and biodiversity.

Este producto está certificado como FSC™ mixto, compuesto de materiales provenientes de bosques responsablemente gestionados y de otras fuentes controladas. La elección de este producto ayuda a la preservación de bosques y la biodiversidad.

PO090

Collection BRIO sièges

rochebobois
PARIS

design Sacha LAKIC



Barstool - Tabouret - Taburete

PO090

Collection BRIO sièges

rochebobois
PARIS

design Sacha LAKIC

Barstool: L 48 x H 88 x P 52,5 cm - L 18^{3/4"} x H 34^{3/4"} x P 20^{3/4"} Pieds en hêtre - coque rembourrée, recouverte en cuir ou tissu.

Tabouret: L 48 x H 88 x P 52,5 cm - L 18^{3/4"} x H 34^{3/4"} x P 20^{3/4"} Beech legs - upholstered shell in leather or fabric.

Taburete: L 48 x H 88 x P 52,5 cm - L 18^{3/4"} x H 34^{3/4"} x P 20^{3/4"} Patas de haya - tapizada en cuero o tela.

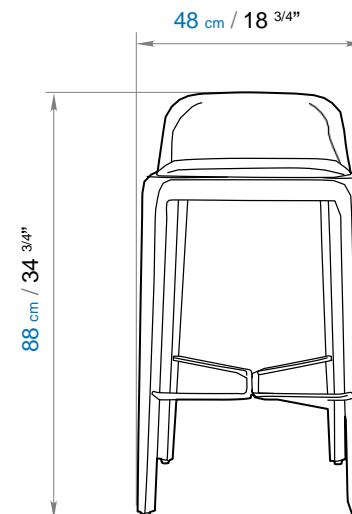
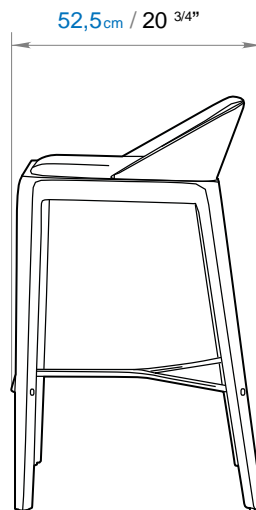

Cette collection est certifiée FSC™ mixte, composée de matériaux provenant de forêts certifiées FSC™ gérées de façon responsable et d'autres sources contrôlées. Le choix de cette collection participe à la préservation des forêts et de la biodiversité.

This collection is certified as FSC™ mix, composed of materials from responsibly managed forest and other controlled sources. The choice of this collection contributes to the preservation of forests and biodiversity.

Esta colección está certificada como FSC™ mixto, compuesta de materiales provenientes de bosques responsablemente gestionados y de otras fuentes controladas. La elección de esta colección ayuda a la preservación de bosques y la biodiversidad.

