

ITINERAIRE CUIR

rochebobois
PARIS

design Philippe BOUIX



ITINERAIRE CUIR

rocheboboïs
PARIS

design Philippe BOUIX

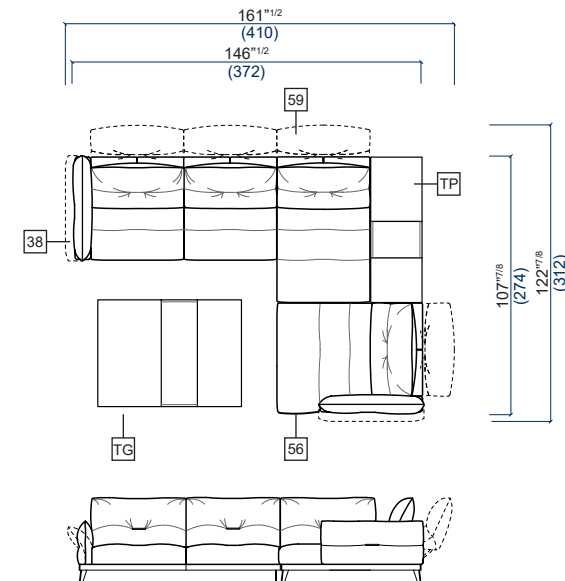

TP Table rectangulaire
Rectangular table
Mesa rectangular

TG Grande table rectangulaire
Large rectangular table
Gran mesa rectangular

38 Bâtard 3 places gauche - dossiers mobiles
3-seat 1-arm unit left - 2-position backrests
Batard 3 plazas izquierdo - respaldos móviles

59 Chaise longue - dossier mobile
Lounge chair - 2-position backrest
Chaise longue - respaldo móvil

56 Chaise longue droite - dossier mobile
Lounge chair - Right - 2-position backrest
Chaise longue derecha - respaldo móvil

ITINERAIRE CUIR

rochebobois
PARIS

design Philippe BOUIX



FICHE TECHNIQUE / TECHNICAL SPECIFICATIONS / FICHA TECNICA:

Structure : Acier, sapin massif, multiplis de pin (CARB)
Suspension : Sangles élastiques
Garnissage assise : Mousse polyuréthane tri-densité 23-35-40 kg/m³ et ouate polyester
Garnissage dossier : Mousse polyuréthane bi-densité 25-21 kg/m³, fibre polyester et latex
Garnissage accoudoir : Mousse polyuréthane 45 kg/m³ et ouate polyester
Tables : Panneau de fibres de densité moyenne plaqué chêne
Barrettes dossiers et barrettes extérieur d'accoudoirs : Métal
Piètement : Métal

Structure: Steel, solid fir wood, pine plywood (CARB)
Suspension: elastic straps
Seat cushion: tri-density polyurethane foam 23-35-40 kg/m³ and polyester batting
Back cushion: bi-density polyurethane foam 25-21 kg/m³, polyester fibre and latex
Armrest cushion: polyurethane foam 45 kg/m³ and polyester batting
Tables: Medium-density fibreboard with oak veneer
Back and exterior armrests straps: Metal
Legs: Metal

Estructura: Acero, abeto macizo, multilaminado de pino (CARB)
Suspensión: Cinchas elásticas
Interior asiento: Espuma poliuretano tri-densidad 23-35-40 kg/m³ y guata de poliéster
Interior respaldo: Espuma poliuretano bi-densidad 25-21 kg/m³, fibra de poliéster y látex
Interior apoyabrazo: Espuma poliuretano densidad 45 kg/m³ y guata de poliéster
Mesas: Paneles de fibras de densidad media chapado roble
Barrita respaldo y barrita exterior apoyabrazos: Metal
Patas: Metal

OBSERVATIONS / OBSERVATIONS / OBSERVACIONES:

- Fabrication Européenne
- Base, assise + dossier et accoudoirs démontables
- Assise, dossier et accoudoirs capitonnés
- Accoudoirs mobiles avec mécanisme à deux positions
- Modèle réalisable dans tous les cuirs de la collection Roche Bobois
- Barrettes dossiers, barrettes extérieur d'accoudoirs et piètement réalisés dans la même finition
- Coutures anglaises ton sur ton fil épais
- Manufactured in Europe
- The base, the seat + backrest and the armrests can be disassembled
- Seat, back and armrest cushions are padded
- Mobile armrests with 2-position mechanism
- Model available in all leathers from the Roche Bobois collection
- Back and exterior armrests metal straps and legs with same finish
- Tone-on-tone English stitching, thick thread
- Fabricación europea
- Base, asiento + respaldo y apoyabrazos desmontables
- Asiento, respaldo y apoyabrazos capitonés
- Apoyabrazos móviles con mecanismo con dos posiciones
- Modelo realizable en todas las pieles de la colección Roche Bobois
- Barrita respaldo, barrita exterior apoyabrazos y patas tienen el mismo acabado
- Costuras inglesas tono sobre tono hilo grueso

OPTIONS / OPTIONAL / OPCIONES:

- Dossier disponible en 2 versions : dossier à double profondeur avec mécanisme manuel à balancier et dossier fixe
- Barrettes dossiers, barrettes extérieur d'accoudoirs et piètement disponibles dans 2 finitions : Nickel Noir ou Chromé Brillant. Voir page 4
- Tables disponibles dans 5 finitions : Gris, Sable, Souris, Taupe ou Wengé. Voir page 5
- Backs available in 2 versions: double depth back with adjustable rocking mechanism or fixed back
- Back and exterior armrests metal straps, and legs available in 2 finishes: Black Nickel or Glossy Chrome-Plated finish. See page 4
- Tables available in 5 finishings: Gris, Sable, Souris, Taupe or Wengé. See page 5
- Respaldo disponible en 2 versiones: respaldo de doble profundidad con mecanismo manual a balancín y respaldo fijo
- Barrita respaldo, barrita exterior apoyabrazos y patas disponibles en 2 acabados: Níquel Negro o Cromado Brillante. Ver página 4
- Mesas disponibles en 5 acabados: Gris, Sable, Souris, Taupe o Wengé. Ver página 5

design Philippe BOUIX

FINITIONS BARRETTES ET PIEMENT / METAL STRAPS AND LEGS FINISH / ACABADO BARRITAS Y PATAS

BARRETTES DOSSIERS ET EXTERIEUR D'ACCOUDOIRS / BACK AND EXTERIOR ARMRESTS METAL STRAPS / BARRITAS RESPALDO Y EXTERIOR APOYABRAZOS



Nickel Noir
Black Nickel
Níquel Negro



Chromé Brillant
Glossy Chrome-plated
Cromado Brillante

PIEMENT / LEG / PATAS



Nickel Noir
Black Nickel
Níquel Negro



Chromé Brillant
Glossy Chrome-plated
Cromado Brillante

design Philippe BOUIX

FINITIONS TABLE / TABLE FINISH / ACABADO MESA



Teinte Gris
Grey stain
Tinte Gris



Teinte Sable
Sable stain
Tinte Sable



Teinte Souris
Souris stain
Tinte Souris



Teinte Taupe
Taupe stain
Tinte Taupe



Teinte Wengé
Wenge stain
Tinte Wengé



design Philippe BOUIX

DIMENSIONS COMMUNES A TOUS LES ELEMENTS / SAME DIMENSIONS FOR ALL ELEMENTS / MEDIDAS COMUNES A TODOS LOS ELEMENTOS

Les dimensions reportées (profondeur et hauteur de l'élément, profondeur et hauteur de l'assise, largeur des accoudoirs) sont communes à tous les éléments.

The dimensions below (depth and height of the element, depth and height of the seat cushion, width of the armrests) are the same for all elements.

Las medidas mencionadas (profundidad y altura del elemento, profundidad y altura del asiento, ancho de los apoyabrazos), son comunes a todos los elementos.

ACCOUDOIRS MOBILES - COUSSIN DOSSIER LARGEUR 85CM
2-POSITION ARMRESTS - WIDTH 85CM BACKREST CUSHION
APOYABRAZOS MOVILES - COJIN DE RESPALDO ANCHO 85CM

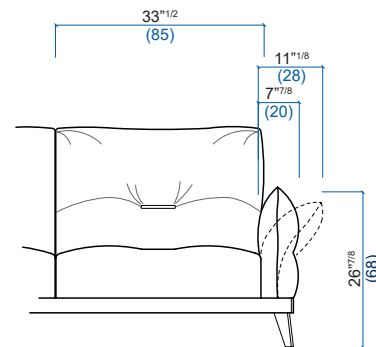

ACCOUDOIRS MOBILES - COUSSIN DOSSIER LARGEUR 100CM
2-POSITION ARMRESTS - WIDTH 100CM BACKREST CUSHION
APOYABRAZOS MOVILES - COJIN DE RESPALDO ANCHO 100CM

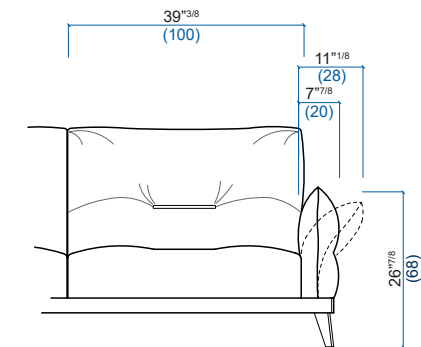

DOSSIERS MOBILES - POSITION OUVERTE
2-POSITION BACKRESTS - OPENED POSITION
RESPALDOS MOVILES - POSICION ABIERTA

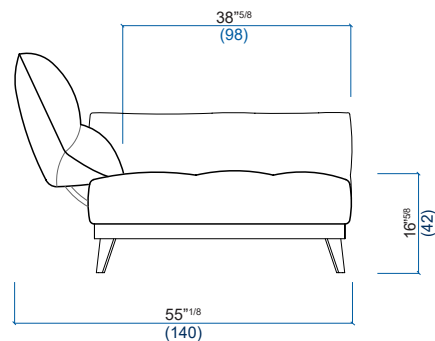

DOSSIERS MOBILES - POSITION FERMEE
2-POSITION BACKRESTS - CLOSED POSITION
RESPALDOS MOVILES - POSICION CERRADA

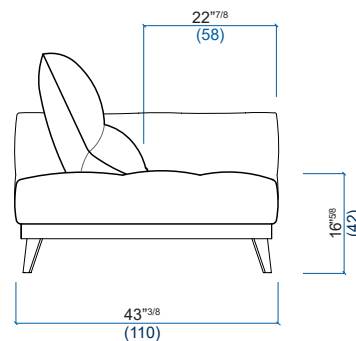

DOSSIERS FIXES
FIXED BACKRESTS
RESPALDOS FIJOS

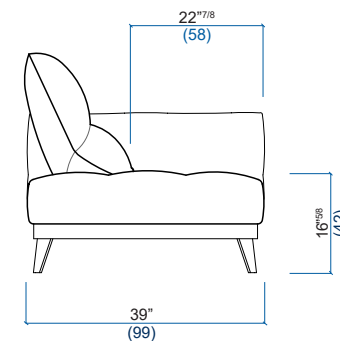

design Philippe BOUIX

DOSSIERS MOBILES L.85CM / W.85CM 2-POSITION BACKRESTS / RESPALDOS MOVILES A.85CM

DOSSIERS MOBILES L.100CM / W.100CM 2-POSITION BACKRESTS / RESPALDOS MOVILES A.100CM

09 Fauteuil
Armchair
Sillón

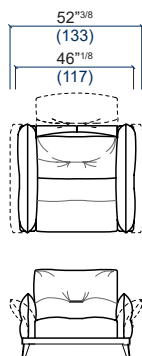
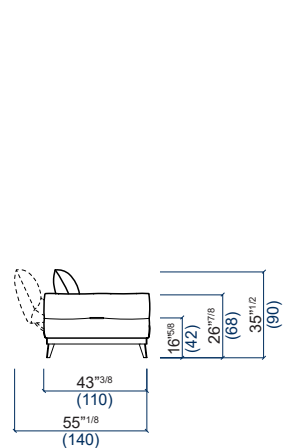

10 Grand fauteuil
Large armchair
Gran sillón

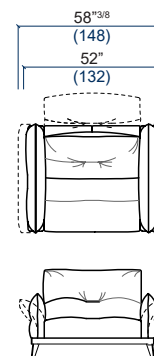

DOSSIERS FIXES L.85CM / W.85CM FIXED BACKRESTS / RESPALDOS FIJOS A.85CM

DOSSIERS FIXES L.100CM / W.100CM FIXED BACKRESTS / RESPALDOS FIJOS A.100CM

09 Fauteuil
Armchair
Sillón

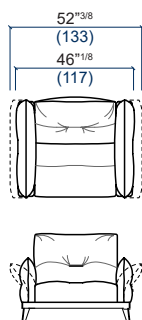
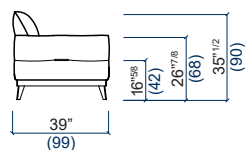

10 Grand fauteuil
Large armchair
Gran sillón

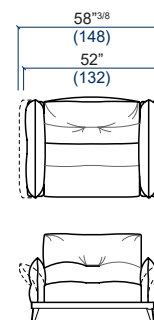

design Philippe BOUIX

DOSSIERS MOBILES L.85CM / W.85CM 2-POSITION BACKRESTS / RESPALDOS MOVILES A.85CM

DOSSIERS MOBILES L.100CM / W.100CM 2-POSITION BACKRESTS / RESPALDOS MOVILES A.100CM

24 Canapé 3 places
3-seat sofa
Sofá 3 plazas

34 Grand canapé 4 places
Large 4-seat sofa
Gran sofá 4 plazas

30 Grand canapé 3 places
Large 3-seat sofa
Gran sofá 3 plazas

35 Canapé 5 places
5-seat sofa
Sofá 5 plazas

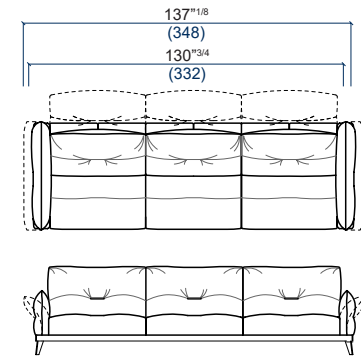
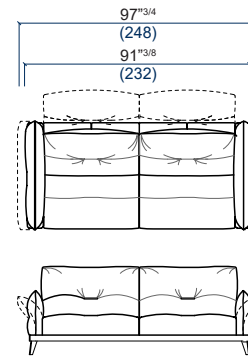
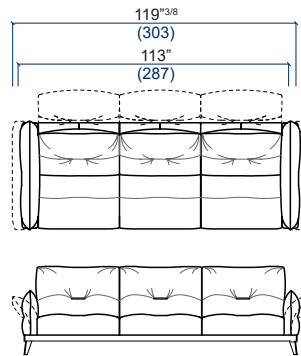
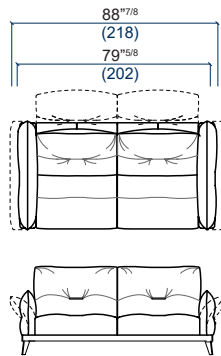
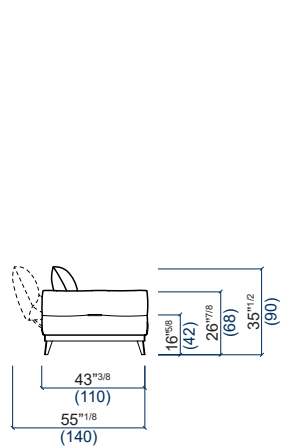

DOSSIERS FIXES L.85CM / W.85CM FIXED BACKRESTS / RESPALDOS FIJOS A.85CM

DOSSIERS FIXES L.100CM / W.100CM FIXED BACKRESTS / RESPALDOS FIJOS A.100CM

24 Canapé 3 places
3-seat sofa
Sofá 3 plazas

34 Grand canapé 4 places
Large 4-seat sofa
Gran sofá 4 plazas

30 Grand canapé 3 places
Large 3-seat sofa
Gran sofá 3 plazas

35 Canapé 5 places
5-seat sofa
Sofá 5 plazas

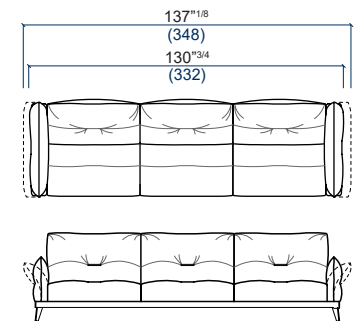
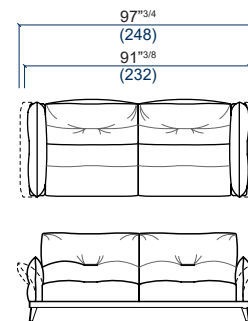
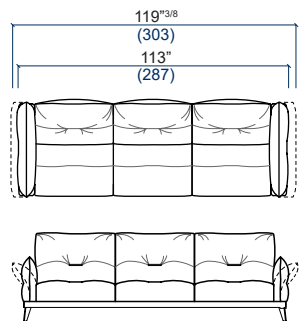
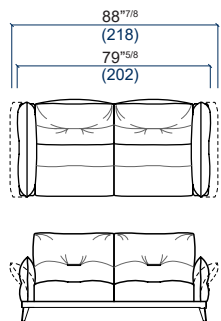
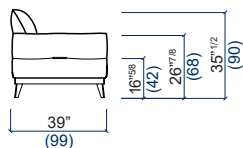

design Philippe BOUIX

DOSSIERS MOBILES L.85CM / W.85CM 2-POSITION BACKRESTS / RESPALDOS MOVILES A.85CM

73 Grand bâtarde 4 places gauche
Large 4-seat 1-arm unit left
Gran batard 4 plazas izquierdo

72 Grand bâtarde 4 places droit
Large 4-seat 1-arm unit right
Gran batard 4 plazas derecho

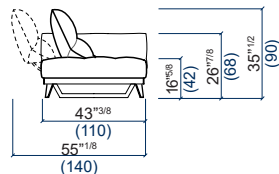
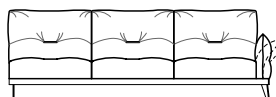
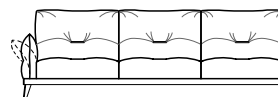
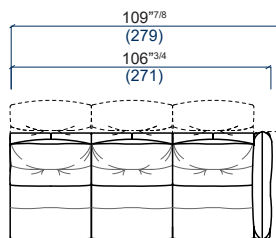
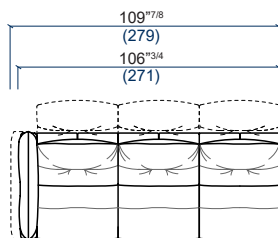

DOSSIERS MOBILES L.100CM / W.100CM 2-POSITION BACKRESTS / RESPALDOS MOVILES A.100CM

78 Grand bâtarde 5 places gauche
Large 5-seat 1-arm unit left
Gran batard 5 plazas izquierdo

77 Grand bâtarde 5 places droit
Large 5-seat 1-arm unit right
Gran batard 5 plazas derecho

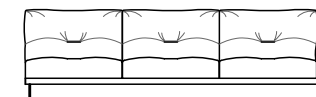
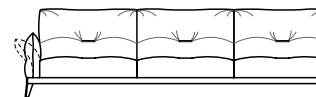
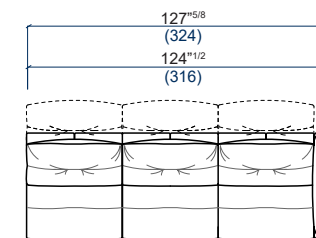
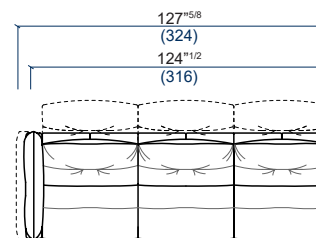

DOSSIERS FIXES L.85CM / W.85CM FIXED BACKRESTS / RESPALDOS FIJOS A.85CM

73 Grand bâtarde 4 places gauche
Large 4-seat 1-arm unit left
Gran batard 4 plazas izquierdo

72 Grand bâtarde 4 places droit
Large 4-seat 1-arm unit right
Gran batard 4 plazas derecho

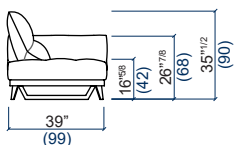
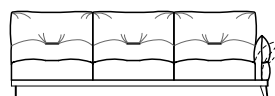
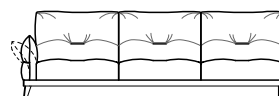
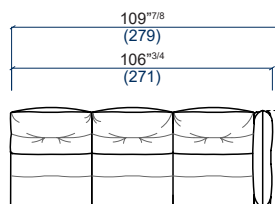
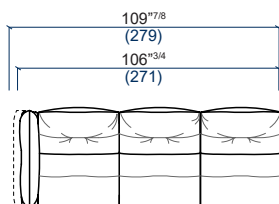

DOSSIERS FIXES L.100CM / W.100CM FIXED BACKRESTS / RESPALDOS FIJOS A.100CM

78 Grand bâtarde 5 places gauche
Large 5-seat 1-arm unit left
Gran batard 5 plazas izquierdo

77 Grand bâtarde 5 places droit
Large 5-seat 1-arm unit right
Gran batard 5 plazas derecho

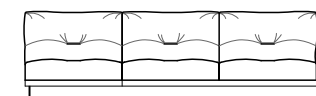
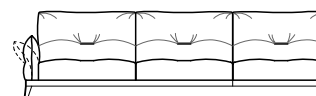
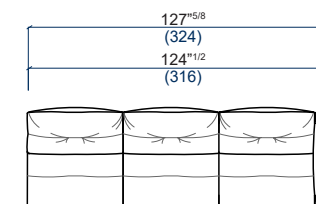
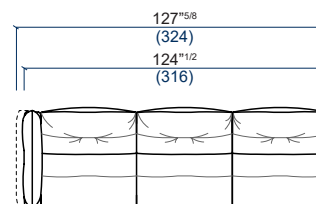

Les BATARDS D/G seront nécessairement associés, dans une composition, à une CHAISE LONGUE D/G, un GRAND ANGLE PANORAMIQUE, un TERMINAL, une BANQUETTE ou à un autre BATARD
In a composition, L/R 1-ARM UNITS must be associated with a L/R LOUNGE CHAIR, a LARGE PANORAMIC CORNER-UNIT, an END UNIT, an ARMLESS SOFA, or another L/R 1-ARM UNIT
Elementos BATARD D/I utilizables únicamente en una composición con una CHAISE LONGUE D/I, un GRAN ANGULO PANORAMICO, una TERMINAL, una BANQUETA u otro BATARD

design Philippe BOUIX

DOSSIERS MOBILES L.85CM / W.85CM 2-POSITION BACKRESTS / RESPALDOS MOVILES A.85CM

DOSSIERS MOBILES L.100CM / W.100CM 2-POSITION BACKRESTS / RESPALDOS MOVILES A.100CM

33 Bâtard 2.5 places gauche
2.5-seat 1-arm unit left
Batard 2.5 plazas izquierdo

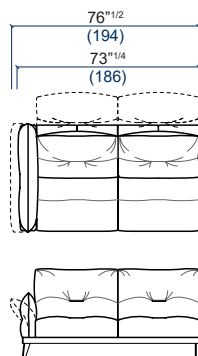

32 Bâtard 2.5 places droit
2.5-seat 1-arm unit right
Batard 2.5 plazas derecho

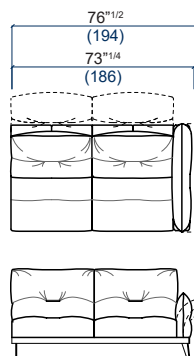

38 Bâtard 3 places gauche
3-seat 1-arm unit left
Batard 3 plazas izquierdo

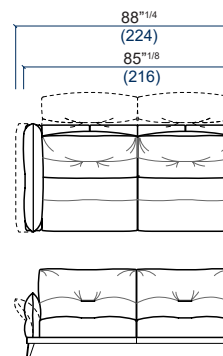

37 Bâtard 3 places droit
3-seat 1-arm unit right
Batard 3 plazas derecho

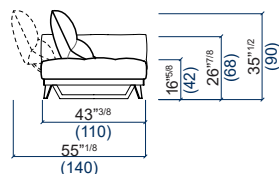
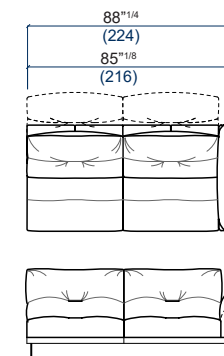

DOSSIERS FIXES L.85CM / W.85CM FIXED BACKRESTS / RESPALDOS FIJOS A.85CM

DOSSIERS FIXES L.100CM / W.100CM FIXED BACKRESTS / RESPALDOS FIJOS A.100CM

33 Bâtard 2.5 places gauche
2.5-seat 1-arm unit left
Batard 2.5 plazas izquierdo

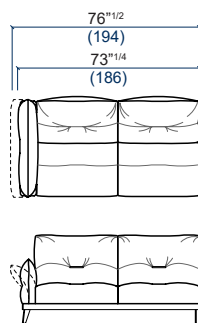

32 Bâtard 2.5 places droit
2.5-seat 1-arm unit right
Batard 2.5 plazas derecho

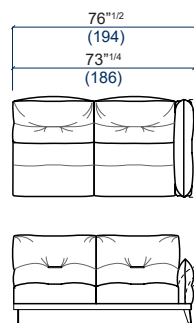

38 Bâtard 3 places gauche
3-seat 1-arm unit left
Batard 3 plazas izquierdo

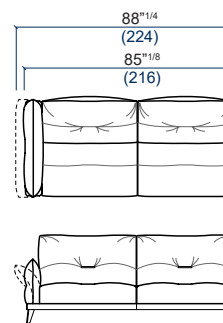

37 Bâtard 3 places droit
3-seat 1-arm unit right
Batard 3 plazas derecho

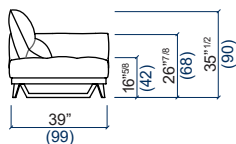
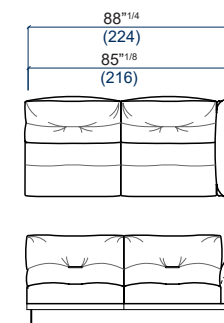

Les BATARDS D/G seront nécessairement associés, dans une composition, à une CHAISE LONGUE D/G, un GRAND ANGLE PANORAMIQUE, un TERMINAL, une BANQUETTE ou à un autre BATARD
In a composition, L/R 1-ARM UNITS must be associated with a L/R LOUNGE CHAIR, a LARGE PANORAMIC CORNER-UNIT, an END UNIT, an ARMLESS SOFA, or another L/R 1-ARM UNIT
Elementos BATARD D/I utilizables únicamente en una composición con una CHAISE LONGUE D/I, un GRAN ANGULO PANORAMICO, una TERMINAL, una BANQUETA u otro BATARD

design Philippe BOUIX

DOSSIERS MOBILES L.85CM / W.85CM 2-POSITION BACKRESTS / RESPALDOS MOVILES A.85CM

DOSSIERS MOBILES L.100CM / W.100CM 2-POSITION BACKRESTS / RESPALDOS MOVILES A.100CM

15 Bâtard 1 place gauche
1-seat 1-arm unit left
Batard 1 plazas izquierdo

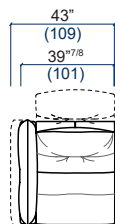

16 Bâtard 1 place droit
1-seat 1-arm unit right
Batard 1 plazas derecho

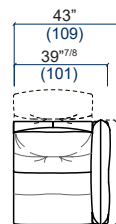

17 Bâtard 1 place gauche
1-seat 1-arm unit left
Batard 1 plazas izquierdo

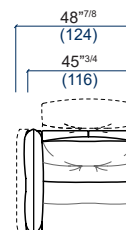

18 Bâtard 1 place droit
1-seat 1-arm unit right
Batard 1 plazas derecho

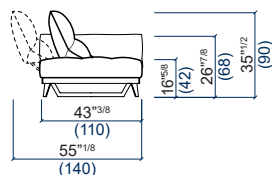
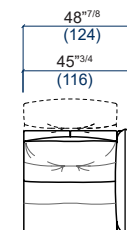

DOSSIERS FIXES L.85CM / W.85CM FIXED BACKRESTS / RESPALDOS FIJOS A.85CM

DOSSIERS FIXES L.100CM / W.100CM FIXED BACKRESTS / RESPALDOS FIJOS A.100CM

15 Bâtard 1 place gauche
1-seat 1-arm unit left
Batard 1 plazas izquierdo

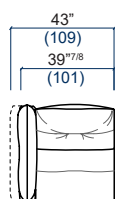

16 Bâtard 1 place droit
1-seat 1-arm unit right
Batard 1 plazas derecho

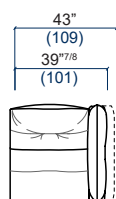

17 Bâtard 1 place gauche
1-seat 1-arm unit left
Batard 1 plazas izquierdo

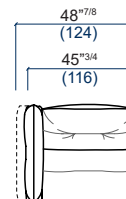

18 Bâtard 1 place droit
1-seat 1-arm unit right
Batard 1 plazas derecho

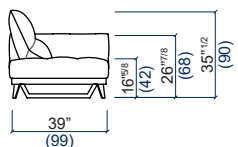
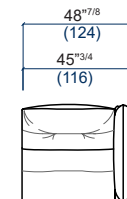

Les BATARDS D/G seront nécessairement associés, dans une composition, à une CHAISE LONGUE D/G, un GRAND ANGLE PANORAMIQUE, un TERMINAL, une BANQUETTE ou à un autre BATARD
In a composition, L/R 1-ARM UNITS must be associated with a L/R LOUNGE CHAIR, a LARGE PANORAMIC CORNER-UNIT, an END UNIT, an ARMLESS SOFA, or another L/R 1-ARM UNIT
Elementos BATARD D/I utilizables únicamente en una composición con una CHAISE LONGUE D/I, un GRAN ANGULO PANORAMICO, una TERMINAL, una BANQUETA u otro BATARD

design Philippe BOUIX

DOSSIERS MOBILES L.85CM / W.85CM 2-POSITION BACKRESTS / RESPALDOS MOVILES A.85CM

DOSSIERS MOBILES L.100CM / W.100CM 2-POSITION BACKRESTS / RESPALDOS MOVILES A.100CM

63 Terminal gauche
End unit - Left
Terminal izquierda

62 Terminal droit
End unit - Right
Terminal derecha

67 Grand terminal gauche
Large End unit - Left
Gran terminal izquierda

68 Grand terminal droit
Large End unit - Right
Gran terminal derecha

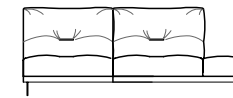
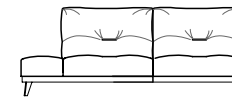
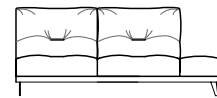
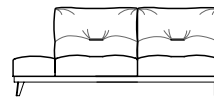
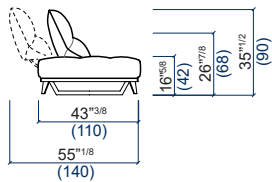
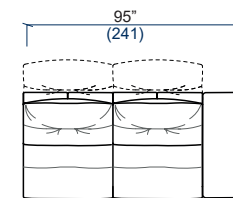
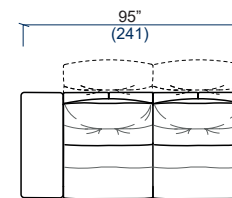
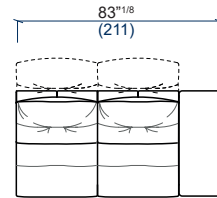
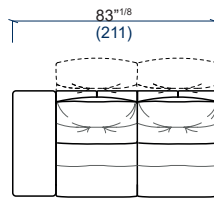

DOSSIERS FIXES L.85CM / W.85CM FIXED BACKRESTS / RESPALDOS FIJOS A.85CM

DOSSIERS FIXES L.100CM / W.100CM FIXED BACKRESTS / RESPALDOS FIJOS A.100CM

63 Terminal gauche
End unit - Left
Terminal izquierda

62 Terminal droit
End unit - Right
Terminal derecha

67 Grand terminal gauche
Large End unit - Left
Gran terminal izquierda

68 Grand terminal droit
Large End unit - Right
Gran terminal derecha

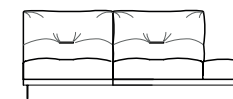
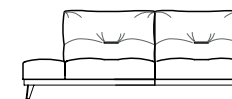
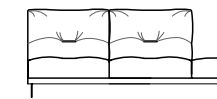
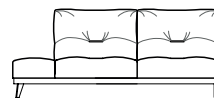
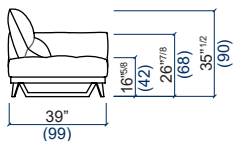
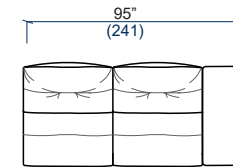
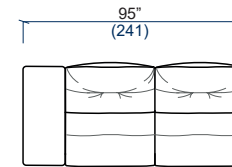
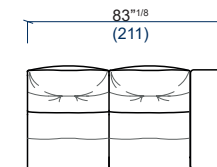
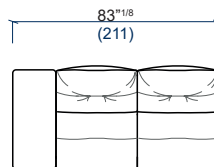

Les TERMINALS D/G seront nécessairement associés, dans une composition, à une CHAISE LONGUE D/G, un GRAND ANGLE PANORAMIQUE, un BATARD, une BANQUETTE ou à un autre TERMINAL
In a composition, L/R END UNITS must be associated with a L/R LOUNGE CHAIR, a LARGE PANORAMIC CORNER-UNIT, a L/R 1-ARM UNIT, an ARMLESS SOFA, or another END UNIT
Elementos TERMINAL D/I utilizables únicamente en una composición con una CHAISE LONGUE D/I, un GRAN ANGULO PANORAMICO, un BATARD, una BANQUETA u otra TERMINAL

design Philippe BOUIX

DOSSIERS MOBILES L.85CM / W.85CM 2-POSITION BACKRESTS / RESPALDOS MOVILES A.85CM

DOSSIERS MOBILES L.100CM / W.100CM 2-POSITION BACKRESTS / RESPALDOS MOVILES A.100CM

61 Petit terminal gauche
Small End unit - Left
Pequeña terminal izquierda

60 Petit terminal droit
Small End unit - Right
Pequeña terminal derecha

65 Petit terminal gauche
Small End unit - Left
Pequeña terminal izquierda

66 Petit terminal droit
Small End unit - Right
Pequeña terminal derecha

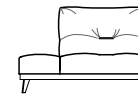
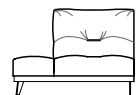
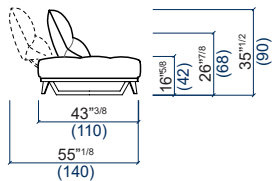
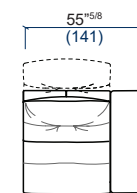
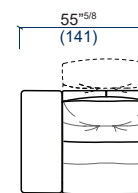
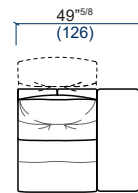
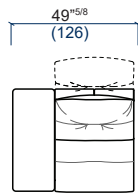

DOSSIERS FIXES L.85CM / W.85CM FIXED BACKRESTS / RESPALDOS FIJOS A.85CM

DOSSIERS FIXES L.100CM / W.100CM FIXED BACKRESTS / RESPALDOS FIJOS A.100CM

61 Petit terminal gauche
Small End unit - Left
Pequeña terminal izquierda

60 Petit terminal droit
Small End unit - Right
Pequeña terminal derecha

65 Petit terminal gauche
Small End unit - Left
Pequeña terminal izquierda

66 Petit terminal droit
Small End unit - Right
Pequeña terminal derecha

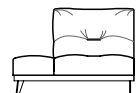
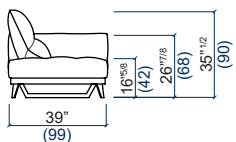
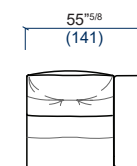
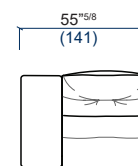
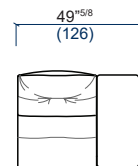
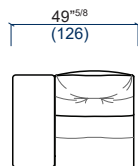

Les TERMINALS D/G seront nécessairement associés, dans une composition, à une CHAISE LONGUE D/G, un GRAND ANGLE PANORAMIQUE, un BATARD, une BANQUETTE ou à un autre TERMINAL
In a composition, L/R END UNITS must be associated with a L/R LOUNGE CHAIR, a LARGE PANORAMIC CORNER-UNIT, a L/R 1-ARM UNIT, an ARMLESS SOFA, or another END UNIT
Elementos TERMINAL D/I utilizables únicamente en una composición con una CHAISE LONGUE D/I, un GRAN ANGULO PANORAMICO, un BATARD, una BANQUETA u otra TERMINAL

design Philippe BOUIX

DOSSIERS MOBILES L.85CM / W.85CM 2-POSITION BACKRESTS / RESPALDOS MOVILES A.85CM

DOSSIERS MOBILES L.100CM / W.100CM 2-POSITION BACKRESTS / RESPALDOS MOVILES A.100CM

64 Banquette 2 places
2-seat armless sofa
Banqueta 2 plazas

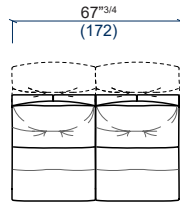

69 Banquette 3 places
3-seat armless sofa
Banqueta 3 plazas

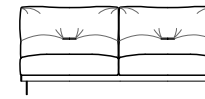
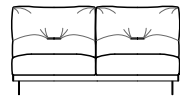
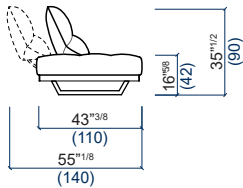
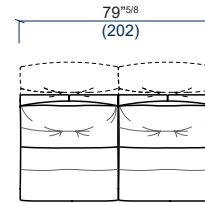

DOSSIERS FIXES L.85CM / W.85CM FIXED BACKRESTS / RESPALDOS FIJOS A.85CM

DOSSIERS FIXES L.100CM / W.100CM FIXED BACKRESTS / RESPALDOS FIJOS A.100CM

64 Banquette 2 places
2-seat armless sofa
Banqueta 2 plazas

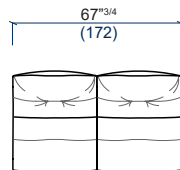

69 Banquette 3 places
3-seat armless sofa
Banqueta 3 plazas

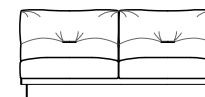
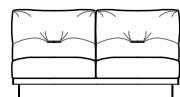
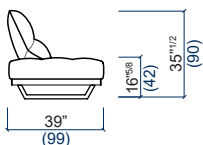
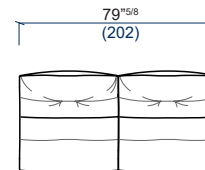

Les BANQUETTES seront nécessairement reliées, sur les deux côtés, à une CHAISE LONGUE D/G, un GRAND ANGLE PANORAMIQUE, un BATARD ou à un autre TERMINAL
In a composition, ARMLESS SOFAS must be attached to a L/R LOUNGE CHAIR, a LARGE PANORAMIC CORNER-UNIT, a L/R 1-ARM UNIT, or another END UNIT on the two sides
Elementos BANQUETA utilizables únicamente en una composición con una CHAISE LONGUE D/I, un GRAN ANGULO PANORAMICO, un BATARD u otra TERMINAL a cada lado

design Philippe BOUIX

DOSSIERS MOBILES L.85CM / W.85CM 2-POSITION BACKRESTS / RESPALDOS MOVILES A.85CM

DOSSIERS MOBILES L.100CM / W.100CM 2-POSITION BACKRESTS / RESPALDOS MOVILES A.100CM

53 Chaise longue gauche
Lounge chair - Left
Chaise longue izquierda

52 Chaise longue droite
Lounge chair - Right
Chaise longue derecha

57 Chaise longue gauche
Lounge chair - Left
Chaise longue izquierda

56 Chaise longue droite
Lounge chair - Right
Chaise longue derecha

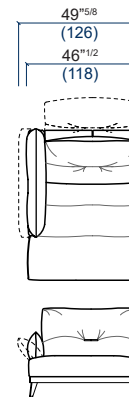
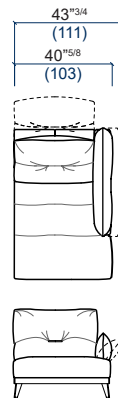
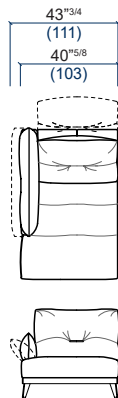
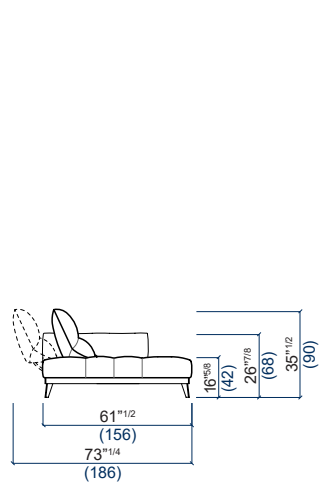

DOSSIERS FIXES L.85CM / W.85CM FIXED BACKRESTS / RESPALDOS FIJOS A.85CM

DOSSIERS FIXES L.100CM / W.100CM FIXED BACKRESTS / RESPALDOS FIJOS A.100CM

53 Chaise longue gauche
Lounge chair - Left
Chaise longue izquierda

52 Chaise longue droite
Lounge chair - Right
Chaise longue derecha

57 Chaise longue gauche
Lounge chair - Left
Chaise longue izquierda

56 Chaise longue droite
Lounge chair - Right
Chaise longue derecha

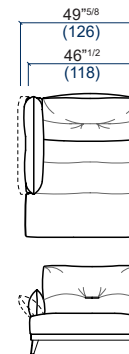
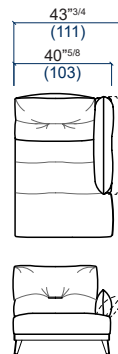
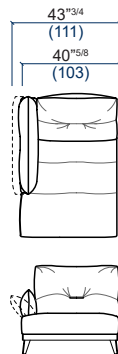
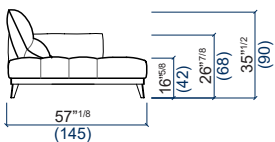

design Philippe BOUIX

DOSSIERS MOBILES L.85CM / W.85CM 2-POSITION BACKRESTS / RESPALDOS MOVILES A.85CM

DOSSIERS MOBILES L.100CM / W.100CM 2-POSITION BACKRESTS / RESPALDOS MOVILES A.100CM

54 Chaise longue
Lounge chair
Chaise longue

14 Chauffeuse
Armless chair
Chauffeuse

59 Chaise longue
Lounge chair
Chaise longue

19 Chauffeuse
Armless chair
Chauffeuse

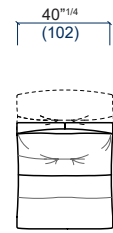
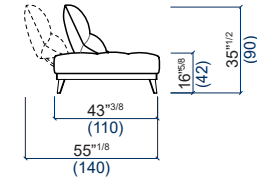
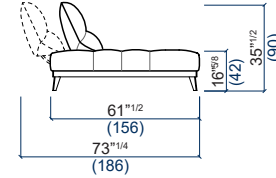
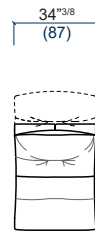
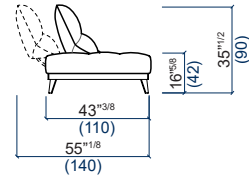
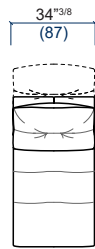
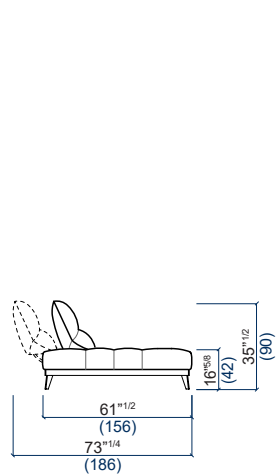

DOSSIERS FIXES L.85CM / W.85CM FIXED BACKRESTS / RESPALDOS FIJOS A.85CM

DOSSIERS FIXES L.100CM / W.100CM FIXED BACKRESTS / RESPALDOS FIJOS A.100CM

54 Chaise longue
Lounge chair
Chaise longue

14 Chauffeuse
Armless chair
Chauffeuse

59 Chaise longue
Lounge chair
Chaise longue

19 Chauffeuse
Armless chair
Chauffeuse

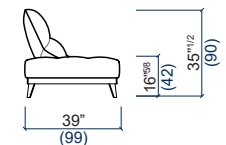
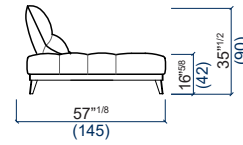
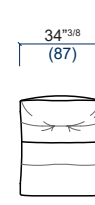
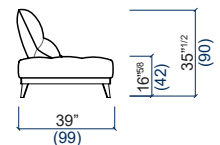
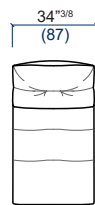
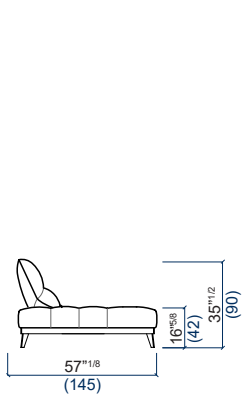

ITINERAIRE CUIR

design Philippe BOUIX

DOSSIERS MOBILES L.100CM / W.100CM 2-POSITION BACKRESTS / RESPALDOS MOVILES A.100CM

51 Grand angle panoramique
Large panoramic corner-unit
Gran ángulo panorámico

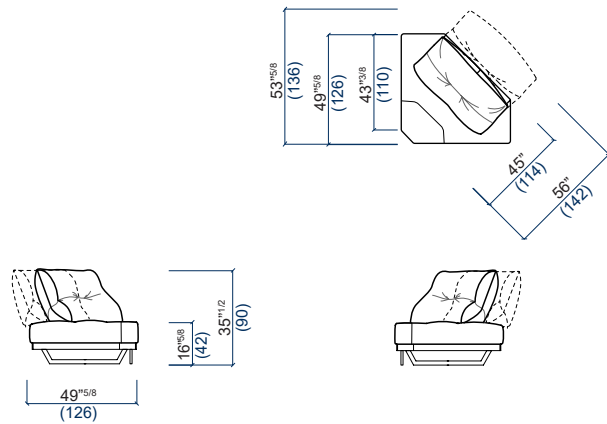

40 Pouf carré
Square ottoman
Puf cuadrado

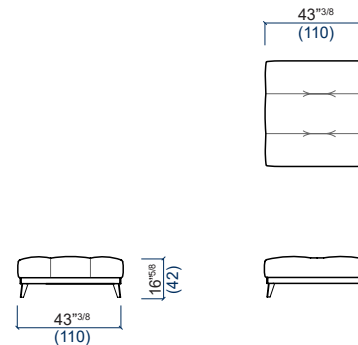

99 Coussin carré
Square cushion
Cojín cuadrado

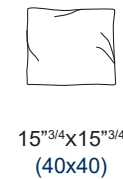

DOSSIERS FIXES L.100CM / W.100CM FIXED BACKRESTS / RESPALDOS FIJOS A.100CM

51 Grand angle panoramique
Large panoramic corner-unit
Gran ángulo panorámico

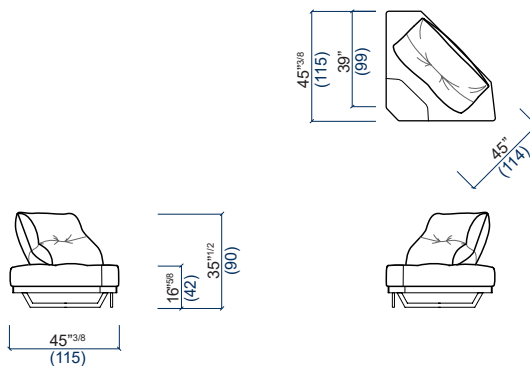

TP Table rectangulaire
Rectangular table
Mesa rectangular

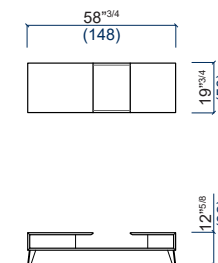

TG Grande table rectangulaire
Large rectangular table
Gran mesa rectangular

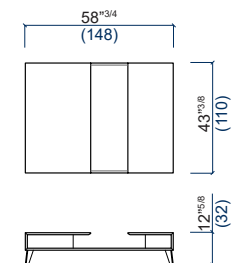

Le GRAND ANGLE PANORAMIQUE sera nécessairement relié, sur les deux côtés, à un élément BATARD, BANQUETTE ou TERMINAL
The LARGE PANORAMIC CORNER-UNIT must be attached to a 1-ARM UNIT, an ARMLESS SOFA, or to an END UNIT on the two sides

17 El GRAN ANGULO PANORAMICO tiene que estar unido a un BATARD, una BANQUETA o un TERMINAL a cada lado del elemento