

# REFLEXION

design Philippe BOUIX

rochebobo**is**  
PARIS



# REFLEXION

design Philippe BOUIX

**rochebobo**  
PARIS



# REFLEXION

design Philippe BOUIX

rochebobois  
PARIS

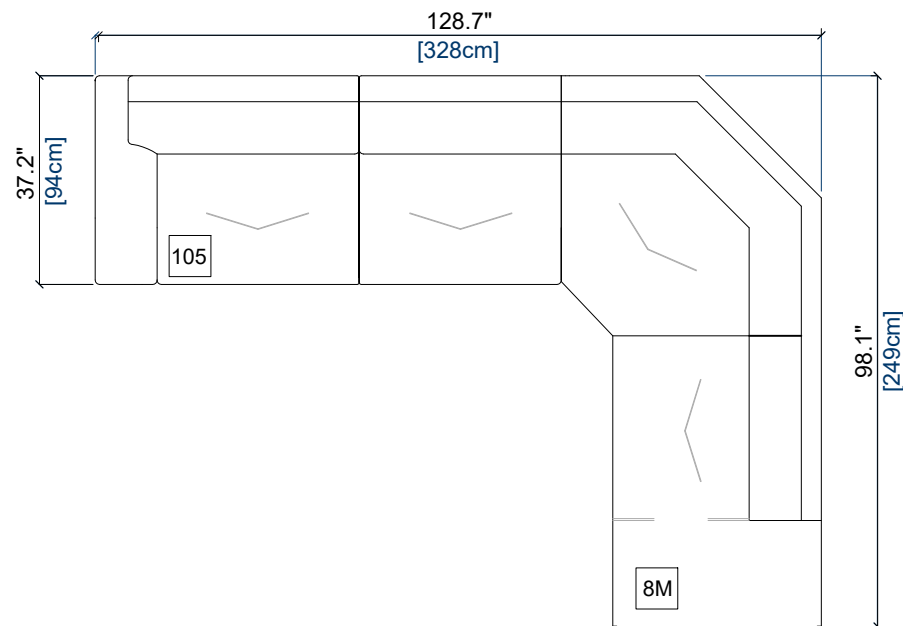

105 BATARD 3 PL ACC. GAUCHE / 3-SEAT 1-ARM UNIT LEFT ARMREST / BATARD 3 PL. APOY. IZQUIERDO

8M ANGLE/MERIDIENNE MAXI GAUCHE PANORAMIQUE / MAXI PANORAMIC CORNER/MERIDIENNE LEFT / ANGULO/MERIDIENNE MAXI PANORAMICO IZQUIERDO

# REFLEXION

design Philippe BOUIX

**rochebobo**is  
PARIS



# REFLEXION

design Philippe BOUIX

rocheboboib  
PARIS



## INFORMATIONS TECHNIQUES / TECHNICAL SPECIFICATIONS / FICHA TECNICA :

Structure : Sapin massif, multiplis de pin (CARB)  
Suspension : Sangles élastiques entrecroisées Extra Larges Haute Résilience  
Garnissage assise Mousse polyuréthane Haute Résilience bi-densité 40-45 kg/m<sup>3</sup>  
Garnissage dossier : Mousse polyuréthane densité 18S kg/m<sup>3</sup>  
Piètement : Métal

Structure: Solid fir wood, pine plywood (CARB)  
Suspension: Extra Wide High Resilience cross Elastic Straps  
Seat cushion: Bi-density High Resilience polyurethane foam 40-45 kg/m<sup>3</sup>  
Back cushion: Polyurethane foam density 18S kg/m<sup>3</sup>  
Base: Metal

Estructura: Abeto macizo, multilaminado de pino (CARB)  
Suspensión: Cinchas elásticas Extra Anchas de Alta Resiliencia entrecruzadas  
Cojines de asiento: Espuma de poliuretano de alta resiliencia bi-densidad 40-45 kg/m<sup>3</sup>  
Cojines de respaldo: Espuma de poliuretano densidad 18S kg/m<sup>3</sup>  
Patas: Metal

## OBSERVATIONS / OBSERVATIONS / OBSERVACIONES :

- Fabrication Européenne
- Modèle réalisable dans l'ensemble des revêtements de la collection ROCHE BOBOIS
- Coutures « Déco » non réalisables en velours
- Certains éléments peuvent être utilisés indépendamment les uns des autres ; par conséquent, ils sont entièrement recouverts de cuir ou de tissu
- Manufactured in Europe
- Model available in all exclusive materials from the ROCHE BOBOIS collection
- "Deco" stitching not available in velvet
- Some elements can be used independently; these elements will be entirely upholstered in fabric or leather
- Fabricación europea
- Modelo realizable en todos los revestimientos de la colección ROCHE BOBOIS
- Costuras decorativas no son posibles en terciopelo
- Algunos elementos pueden ser utilizados independientemente los unos de los otros, en consecuencia, están completamente tapizados de piel o tela

## OPTIONS / OPTIONAL / OPCIONES :

- Confort normal ou ferme
- Coutures et coutures « Déco » contrastées ou ton sur ton
- Piètement : Métal finition vernis mat Anthracite (touché gomme) ou Métal chromé noir (voir page 6)
- Standard or firm comfort
- Contrasting or tone-on tone stitching and "Deco" stitching
- Base: metal with varnish finish, col. matte Anthracite (shellac touch), or black chrome-plated metal (see page 6)
- Confort normal o firme
- Costuras y costuras "Déco" contrastadas, o tono sobre tono.
- Patas: Metal acabado barniz mate Antracita (tacto goma) y Metal cromado negro (ver página 6)

## FINITIONS PIETEMENT / LEG FINISH / ACABADO PATAS



Mat Anthracite (touché gomme)  
Matte Anthracite (shellac touch)  
Mate Antracita (tacto goma)



Chromé Noir  
Black Chrome  
Cromado Negro

# REFLEXION

design Philippe BOUIX

rochebobois  
PARIS

GRAND CANAPÉ 3 PLACES  
LARGE 3-SEAT SOFA  
GRAN SOFA 3 PLAZAS

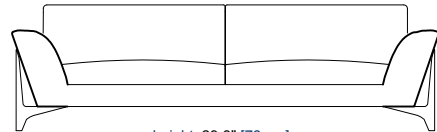
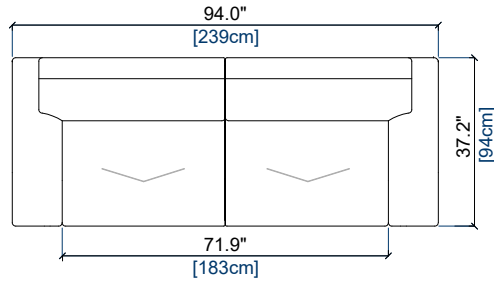

height: 29.8" [76 cm]  
seat height: 16.1" [41 cm]  
arm width: 11.0" [28 cm]

CANAPÉ 3 PLACES  
3-SEAT SOFA  
SOFA 3 PLAZAS

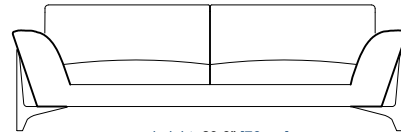
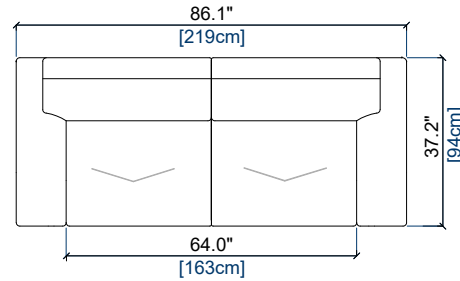

height: 29.8" [76 cm]  
seat height: 16.1" [41 cm]  
arm width: 11.0" [28 cm]

CANAPÉ 2.5 PLACES  
2.5-SEAT SOFA  
SOFA 2,5 PLAZAS

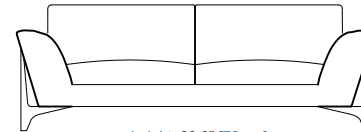
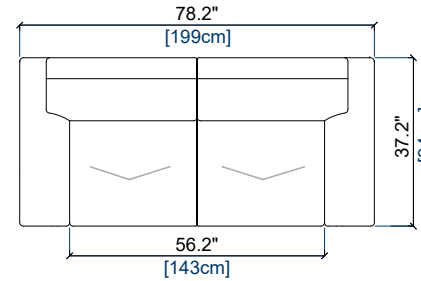

height: 29.8" [76 cm]  
seat height: 16.1" [41 cm]  
arm width: 11.0" [28 cm]

CANAPÉ 2 PLACES  
2-SEAT SOFA  
SOFA 2 PLAZAS

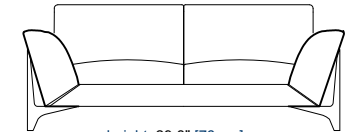
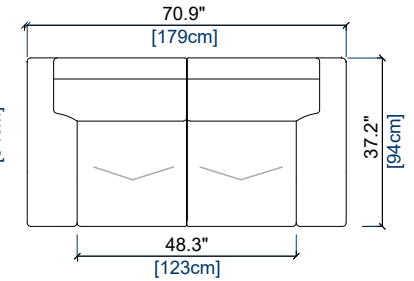

height: 29.8" [76 cm]  
seat height: 16.1" [41 cm]  
arm width: 11.0" [28 cm]

FAUTEUIL  
ARMCHAIR  
SILLON

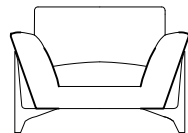
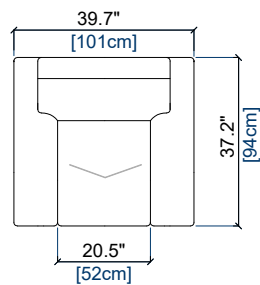

height: 29.8" [76 cm]  
seat height: 16.1" [41 cm]  
arm width: 9.6" [24,5 cm]

POUF  
OTTOMAN  
PUF

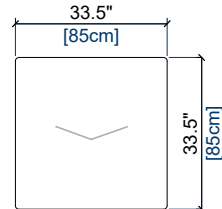

seat height: 16.1" [41 cm]

GRANDE TETIERE  
LARGE HEADREST  
CABEZAL GRAN

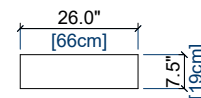

height: 8.7" [22 cm]

MOYENNE TETIERE  
MEDIUM HEADREST  
CABEZAL MEDIANO

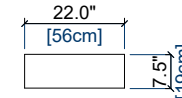

height: 8.7" [22 cm]

PETITE TETIERE  
SMALL HEADREST  
CABEZAL PEQUENO

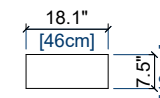

height: 8.7" [22 cm]

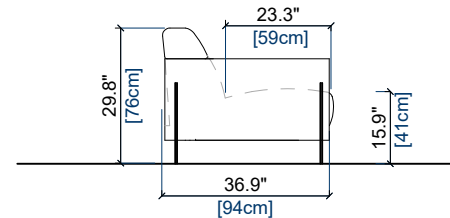

# REFLEXION

design Philippe BOUIX

rochebobo**is**  
PARIS

105 BATARD 3 PL. ACC. GAUCHE  
3-SEAT 1-ARM UNIT LEFT ARMREST  
BATARD 3 PL. APOY. IZQUIERDO

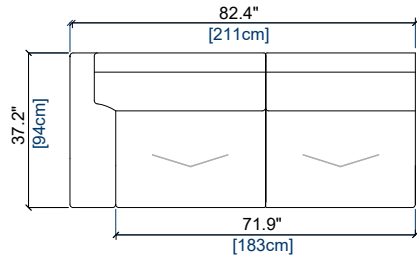

height: 29.8" [76 cm]  
seat height: 16.1" [41 cm]  
arm width: 11.0" [28 cm]

106 BATARD 3 PL. ACC. DROIT  
3-SEAT 1-ARM RIGHT ARMREST  
BATARD 3 PL. APOY. DERECHO

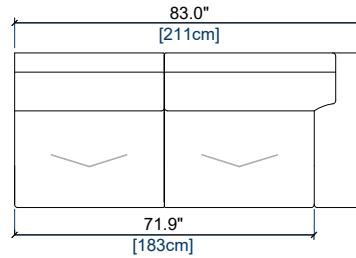

height: 29.8" [76 cm]  
seat height: 16.1" [41 cm]  
arm width: 11.0" [28 cm]

63 BATARD 2,5 PL. ACC. GAUCHE  
2.5-SEAT 1-ARM UNIT LEFT ARMREST  
BATARD 2,5 PL. APOY. IZQUIERDO

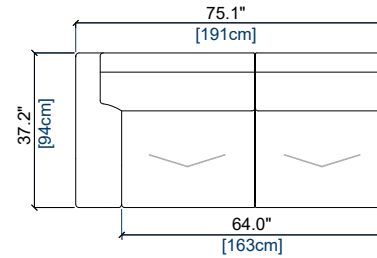

height: 29.8" [76 cm]  
seat height: 16.1" [41 cm]  
arm width: 11.0" [28 cm]

62 BATARD 2,5 PL. ACC. DROIT  
2.5-SEAT 1-ARM UNIT RIGHT ARMREST  
BATARD 2,5 PL. APOY. DERECHO

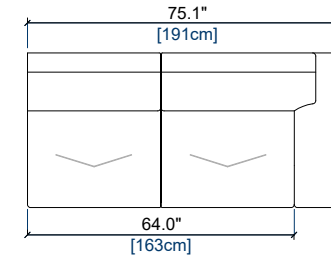

height: 29.8" [76 cm]  
seat height: 16.1" [41 cm]  
arm width: 11.0" [28 cm]

27 BATARD 2 PL. ACC. GAUCHE  
2-SEAT 1-ARM UNIT LEFT ARMREST  
BATARD 2 PL. APOY. IZQUIERDO

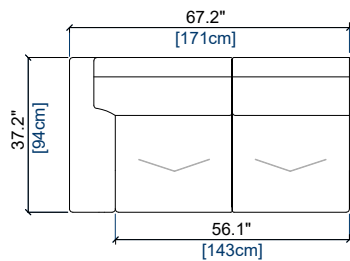

height: 29.8" [76 cm]  
seat height: 16.1" [41 cm]  
arm width: 11.0" [28 cm]

26 BATARD 2 PL. ACC. DROIT  
2-SEAT 1-ARM UNIT RIGHT ARMREST  
BATARD 2 PL. APOY. DERECHO

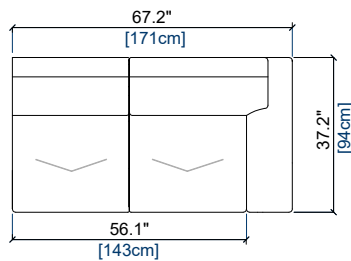

height: 29.8" [76 cm]  
seat height: 16.1" [41 cm]  
arm width: 11.0" [28 cm]

29 BATARD 1 PL. ACC. GAUCHE  
1-SEAT 1-ARM UNIT LEFT ARMREST  
BATARD 1 PL. APOY. IZQUIERDO

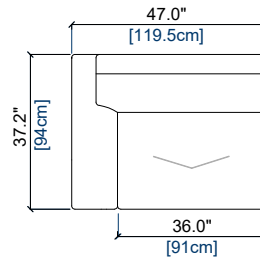

height: 29.8" [76 cm]  
seat height: 16.1" [41 cm]  
arm width: 11.0" [28 cm]

28 BATARD 1 PL. ACC. DROIT  
1-SEAT 1-ARM UNIT RIGHT ARMREST  
BATARD 1 PL. APOY. DERECHO

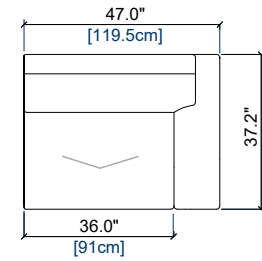

height: 29.8" [76 cm]  
seat height: 16.1" [41 cm]  
arm width: 11.0" [28 cm]

02 ANGLE CARRE  
SQUARE CORNER  
ANGULO CUADRADO

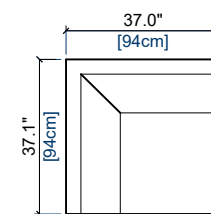

height: 29.8" [76 cm]  
seat height: 16.1" [41 cm]



# REFLEXION

design Philippe BOUIX

rocheboboib  
PARIS

08 GRAND ANGLE/MERIDIENNE GAUCHE  
LARGE CORNER/MERIDIENNE LEFT  
GRAN ANGULO/MERIDIENNE IZQUIERDA

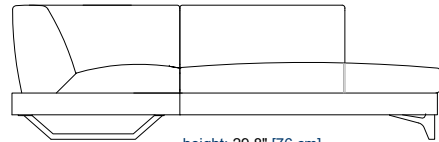
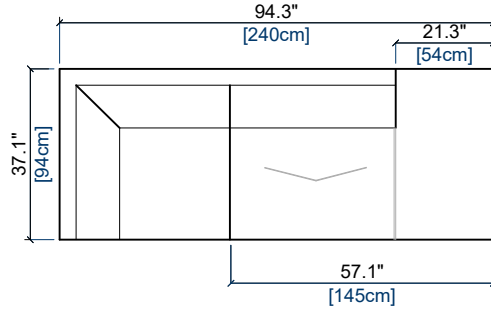

height: 29.8" [76 cm]  
seat height: 16.1" [41 cm]

09 GRAND ANGLE/MERIDIENNE DROITE  
LARGE CORNER/MERIDIENNE RIGHT  
GRAN ANGULO/MERIDIENNE DERECHA

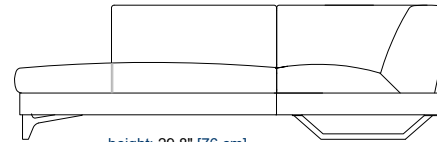
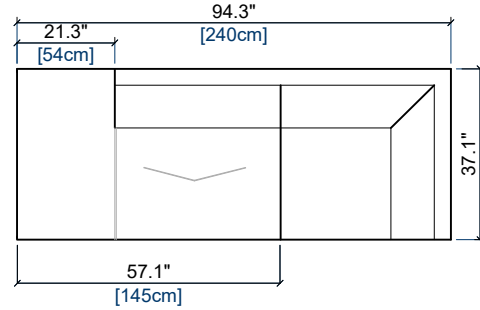

height: 29.8" [76 cm]  
seat height: 16.1" [41 cm]

8P ANGLE/MERIDIENNE GAUCHE  
CORNER/MERIDIENNE LEFT  
ANGULO/MERIDIENNE IZQUIERDA

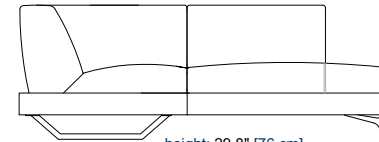
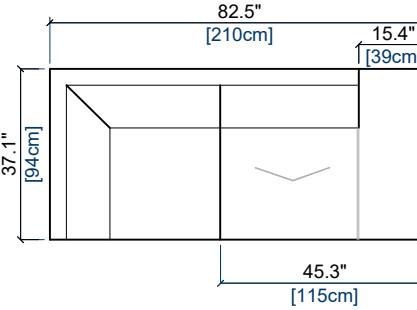

height: 29.8" [76 cm]  
seat height: 16.1" [41 cm]

9P ANGLE/MERIDIENNE DROITE  
CORNER/MERIDIENNE RIGHT  
ANGULO/MERIDIENNE DERECHA

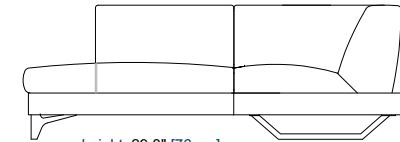
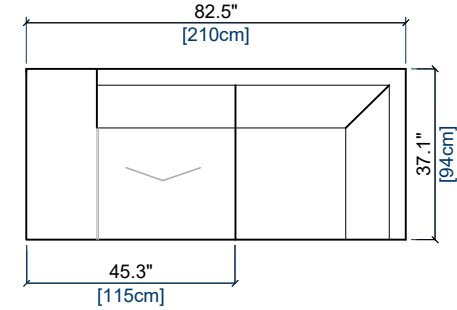

height: 29.8" [76 cm]  
seat height: 16.1" [41 cm]

8M ANGLE/MERIDIENNE MAXI PANORAMIQUE GAUCHE  
MAXI PANORAMIC CORNER/MERIDIENNE LEFT  
ANGULO/MERIDIENNE MAXI PANORAMICO IZQ.

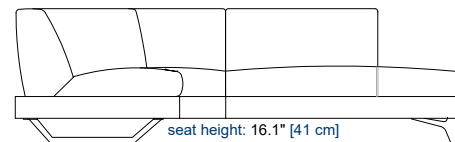
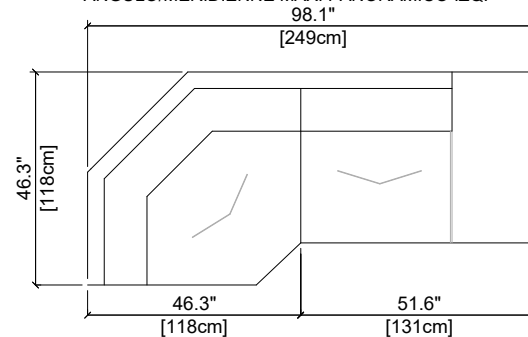

seat height: 16.1" [41 cm]  
height: 29.8" [76 cm]

9M ANGLE/MERIDIENNE MAXI PANORAMIQUE DROITE  
MAXI PANORAMIC CORNER/MERIDIENNE RIGHT  
ANGULO/MERIDIENNE MAXI PANORAMICO DERECHO

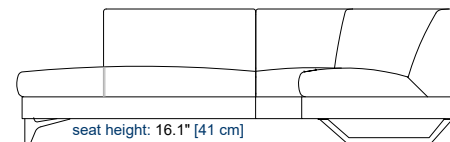
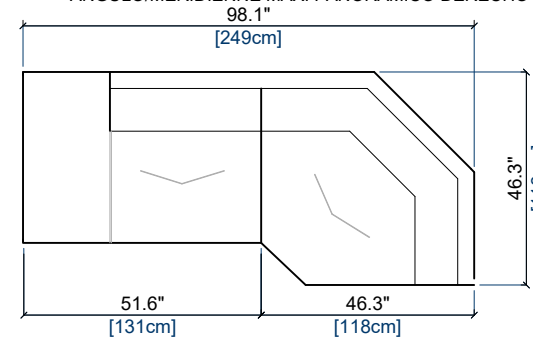

seat height: 16.1" [41 cm]  
height: 29.8" [76 cm]

# REFLEXION

design Philippe BOUIX

**rochebobo**  
PARIS

**8MP** ANGLE/MERIDIENNE PANORAMIQUE GAUCHE  
PANORAMIC CORNER/MERIDIENNE LEFT  
ANGULO/MERIDIENNE PANORAMICO IZQ.

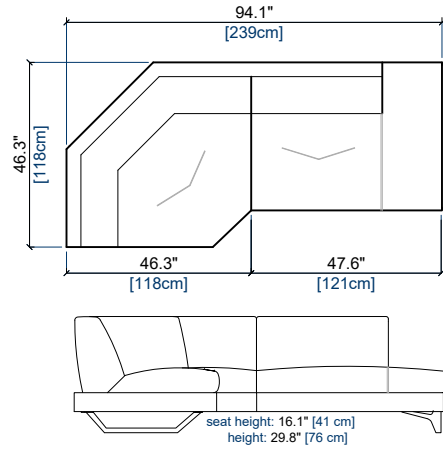

**9MP** ANGLE/MERIDIENNE PANORAMIQUE DROITE  
PANORAMIC CORNER/MERIDIENNE RIGHT  
ANGULO/MERIDIENNE PANORAMICO DER.

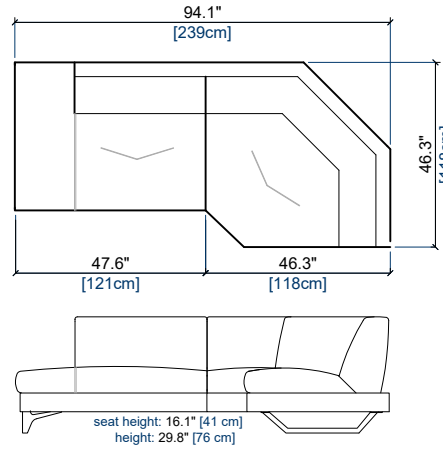

**23** ANGLE ROND  
ROUND CORNER  
ANGULO CURVO

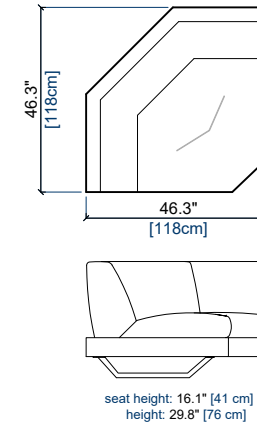

**231** ANGLE PANORAMIQUE GAUCHE ACC. DROIT  
LEFT PANORAMIC CORNER ELEMENT, RIGHT ARM  
ANGULO PANORAMICO IZQUIERDO APOY. DER.

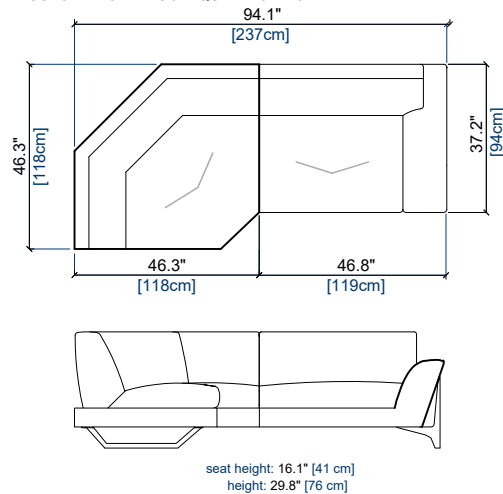

**230** ANGLE PANORAMIQUE DROIT ACC. GAUCHE  
RIGHT PANORAMIC CORNER ELEMENT, LEFT ARM  
ANGULO PANORAMICO DERECHO APOY. IZQU.

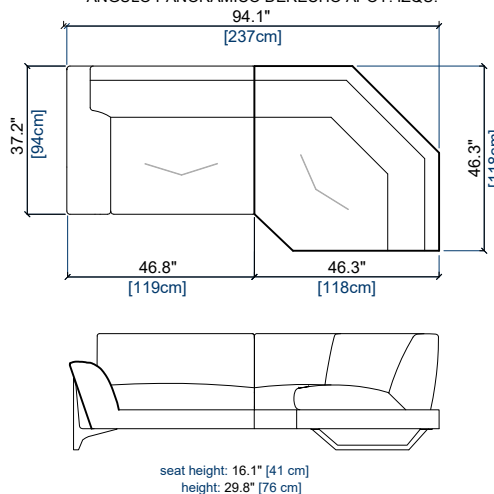

# REFLEXION

design Philippe BOUIX

rocheboboib  
PARIS

11M MOYEN TERMINAL DROIT  
MEDIUM END UNIT RIGHT  
MEDIANA TERMINAL DERECHA

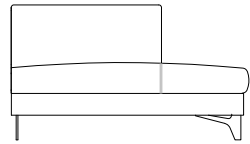
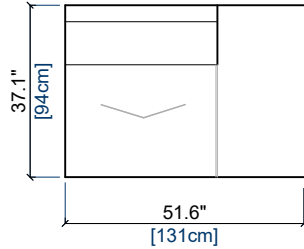

seat height: 16.1" [41 cm]  
height: 29.8" [76 cm]

10M MOYEN TERMINAL GAUCHE  
MEDIUM END UNIT LEFT  
MEDIANA TERMINAL IZQUIERDA

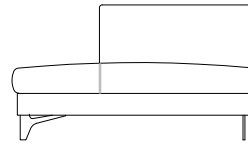
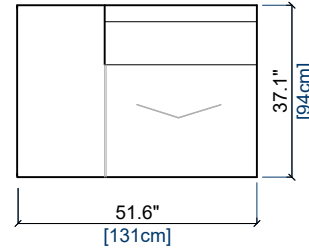

seat height: 16.1" [41 cm]  
height: 29.8" [76 cm]

11P PETIT TERMINAL DROITE  
SMALL END UNIT RIGHT  
PEQUENA TERMINAL DERECHA

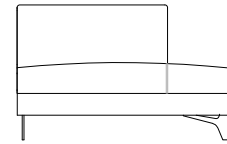
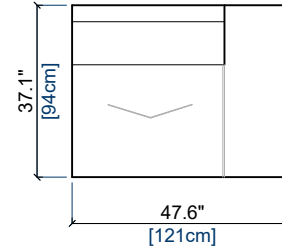

seat height: 16.1" [41 cm]  
height: 29.8" [76 cm]

10P PETIT TERMINAL GAUCHE  
SMALL END UNIT LEFT  
PEQUENA TERMINAL IZQUIERDA

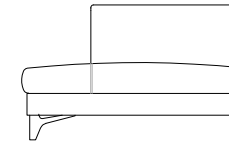
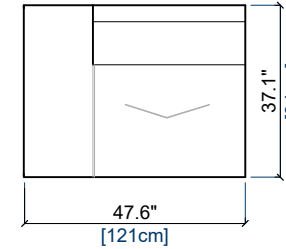

seat height: 16.1" [41 cm]  
height: 29.8" [76 cm]

10 TERMINAL GAUCHE  
END UNIT LEFT  
TERMINAL IZQUIERDA

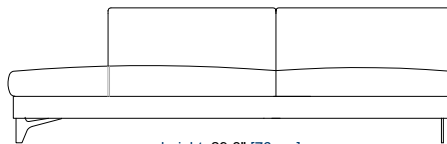
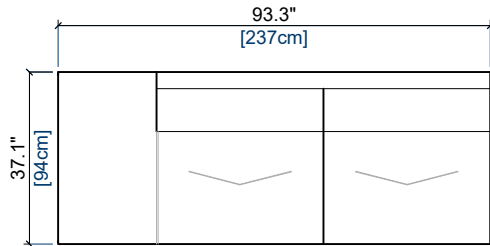

height: 29.8" [76 cm]  
seat height: 16.1" [41 cm]

11 TERMINAL DROIT  
END UNIT RIGHT  
TERMINAL DERECHA

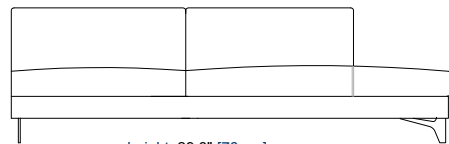
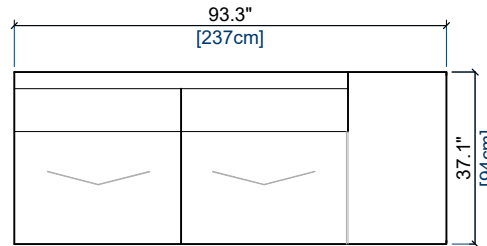

height: 29.8" [76 cm]  
seat height: 16.1" [41 cm]

33 BANQUETTE 2 PLACES  
2-SEAT ARMLESS SOFA  
BANQUETA 2 PLAZAS

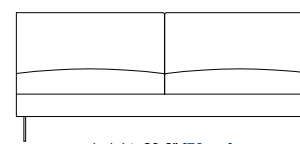
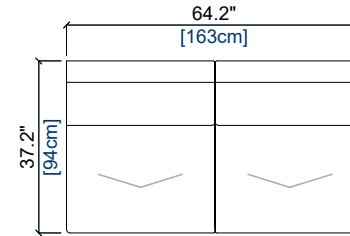

height: 29.8" [76 cm]  
seat height: 16.1" [41 cm]

01 CHAUFFEUSE  
ARMLESS CHAIR  
CHAUFFEUSE

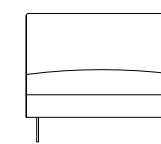
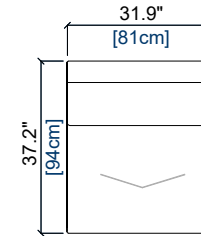

height: 29.8" [76 cm]  
seat height: 16.1" [41 cm]

## ÉLÉMENTS INDÉPENDANTS / INDEPENDENT ELEMENTS / ELEMENTOS INDEPENDIENTES\* 1/4

**S12** BATARD 3 PL ACC. GAUCHE INDEP.  
3-SEAT 1-ARM UNIT LEFT ARMREST INDEP.  
BATARD 3 PL. APOY. IZQU. INDEP.

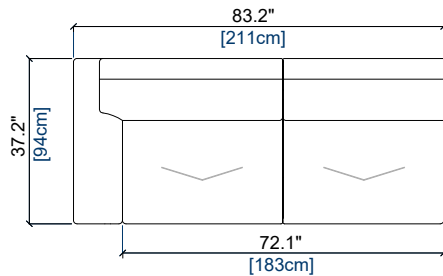

height: 29.8" [76 cm]  
seat height: 16.1" [41 cm]  
arm width: 11.0" [28 cm]

**S13** BATARD 3 PL ACC. DROIT INDEP.  
3-SEAT 1-ARM RIGHT ARMREST INDEP.  
BATARD 3 PL. APOY. DER. INDEP.

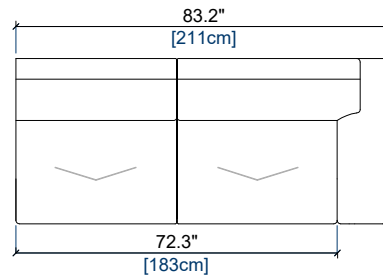

height: 29.8" [76 cm]  
seat height: 16.1" [41 cm]  
arm width: 11.0" [28 cm]

**S63** BATARD 2.5 PL. ACC. GAUCHE INDEP.  
2.5-SEAT 1-ARM UNIT LEFT ARM. INDEP.  
BATARD 2,5 PL. APOY. IZQUIERDA INDEP.

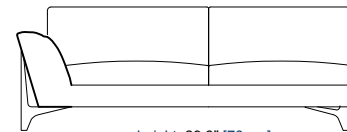
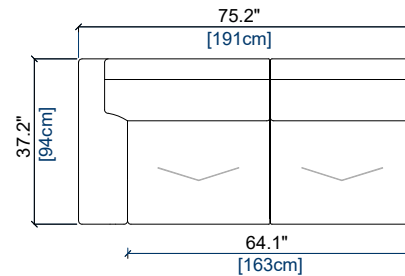

height: 29.8" [76 cm]  
seat height: 16.1" [41 cm]  
arm width: 11.0" [28 cm]

**S62** BATARD 2.5 PL. ACC. DROIT INDEP.  
2.5-SEAT 1-ARM UNIT RIGHT ARM. INDEP.  
BATARD 2,5 PL. APOY. DERECHA INDEP.

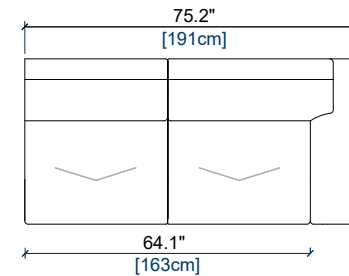

height: 29.8" [76 cm]  
seat height: 16.1" [41 cm]  
arm width: 11.0" [28 cm]

**S27** BATARD 2 PL. ACC. GAUCHE INDEP.  
2-SEAT 1-ARM UNIT LEFT ARM. INDEP.  
BATARD 2 PL. APOY. IZQ. INDEP.

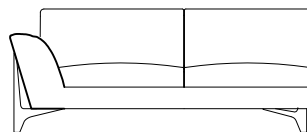
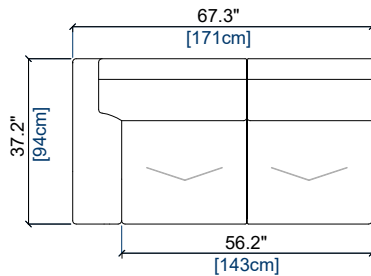

height: 29.8" [76 cm]  
seat height: 16.1" [41 cm]  
arm width: 11.0" [28 cm]

**S26** BATARD 2 PL ACC. DROIT INDEP.  
2-SEAT 1-ARM UNIT RIGHT ARM. INDEP.  
BATARD 2 PL. APOY. DERECHO INDEP.

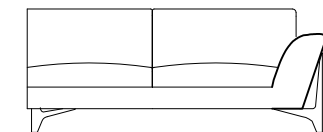
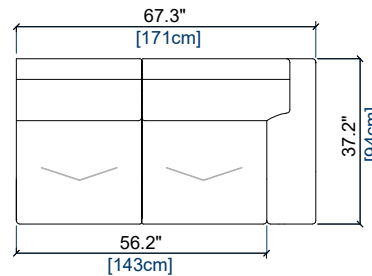

height: 29.8" [76 cm]  
seat height: 16.1" [41 cm]  
arm width: 11.0" [28 cm]

**S29** BATARD 1 PL. ACC. GAUCHE INDEP.  
1-SEAT 1-ARM UNIT LEFT ARM. INDEP.  
BATARD 1 PL. APOY. IZQ. INDEP.

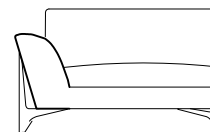
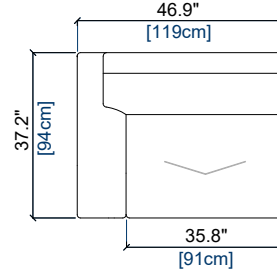

height: 29.8" [76 cm]  
seat height: 16.1" [41 cm]  
arm width: 11.0" [28 cm]

**S28** BATARD 1 PL ACC. DROIT INDEP.  
1-SEAT 1-ARM UNIT RIGHT ARM. INDEP.  
BATARD1 PL. APOY. DERECHO INDEP.

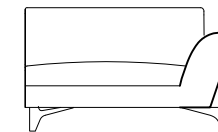
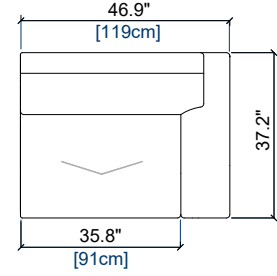

height: 29.8" [76 cm]  
seat height: 16.1" [41 cm]  
arm width: 11.0" [28 cm]

\* Entièrement habillés de cuir ou de tissu / Entirely upholstered in leather or fabric / Completamente revestidos de piel o tela

## ÉLÉMENTS INDÉPENDANTS / INDEPENDENT ELEMENTS / ELEMENTOS INDEPENDIENTES\* 2/4

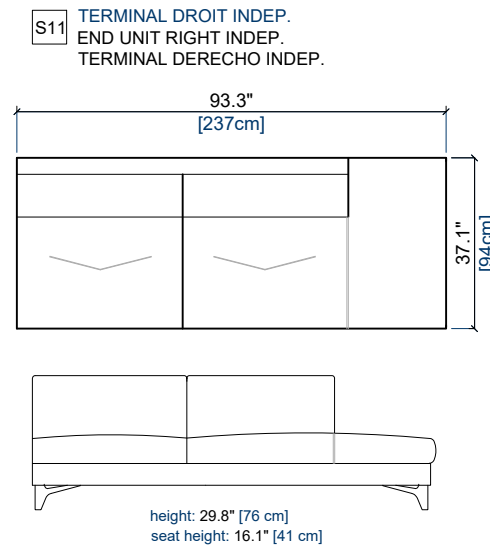
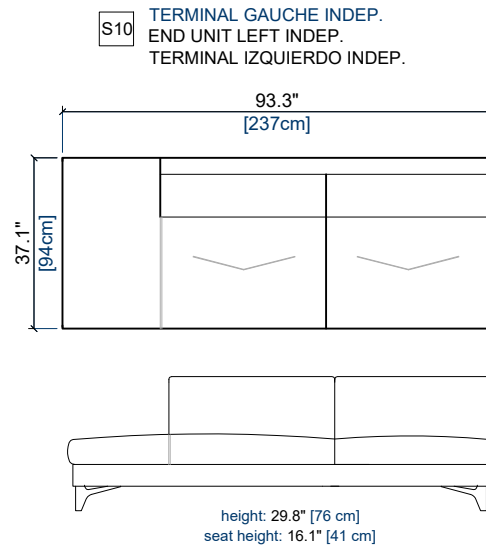
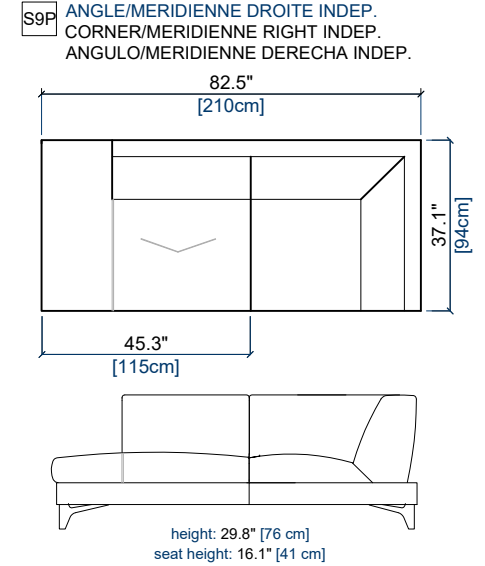
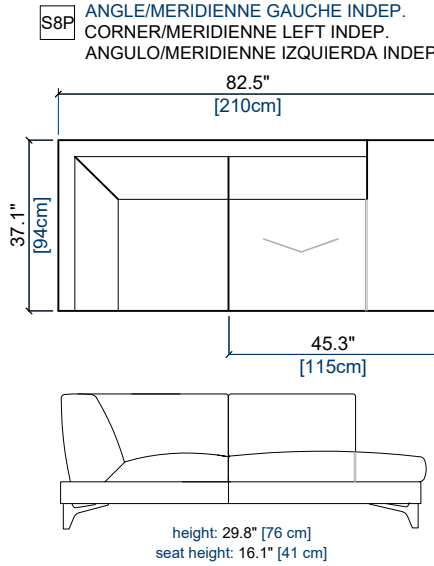
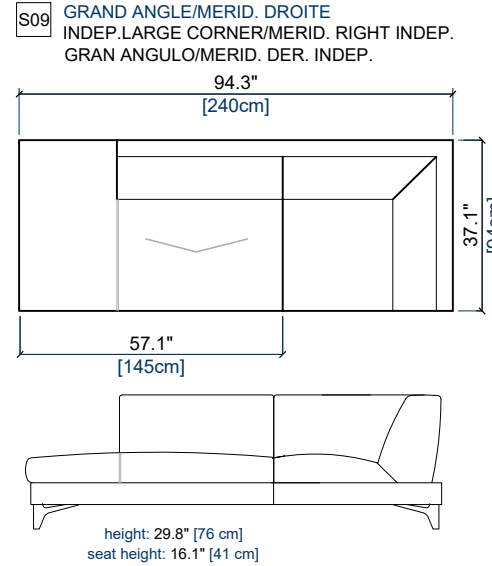
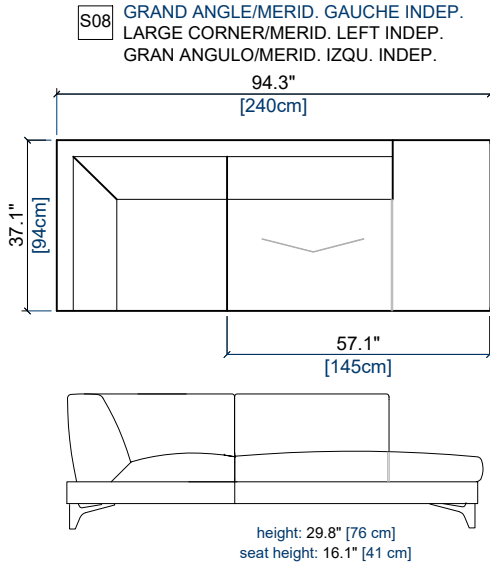

\* Entièrement habillés de cuir ou de tissu / Entirely upholstered in leather or fabric / Completamente revestidos de piel o tela

## ÉLÉMENTS INDÉPENDANTS / INDEPENDENT ELEMENTS / ELEMENTOS INDEPENDIENTES\* 3/4

227 MOYEN TERMINAL DROIT INDEP.  
MEDIUM END UNIT RIGHT INDEP.  
MEDIANA TERMINAL DERECHA INDEP.

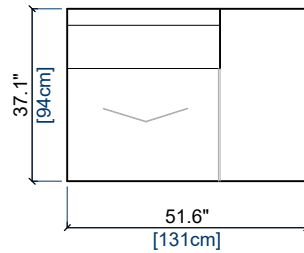

seat height: 16.1" [41 cm]  
height: 29.8" [76 cm]

226 MOYEN TERMINAL GAUCHE INDEP.  
MEDIUM END UNIT LEFT INDEP.  
MEDIANA TERMINAL IZQUIERDO INDEP.

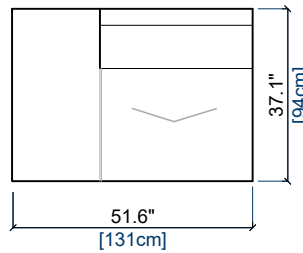

seat height: 16.1" [41 cm]  
height: 29.8" [76 cm]

229 PETIT TERMINAL DROITE INDEP.  
SMALL END UNIT RIGHT INDEP.  
PEQUENA TERMINAL DER. INDEP.

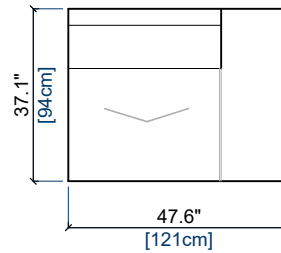

seat height: 16.1" [41 cm]  
height: 29.8" [76 cm]

228 PETIT TERMINAL GAUCHE INDEP.  
SMALL END UNIT LEFT INDEP.  
PEQUENA TERMINAL IZQ. INDEP.

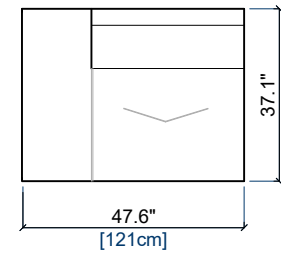

seat height: 16.1" [41 cm]  
height: 29.8" [76 cm]

\* Entièrement habillés de cuir ou de tissu / Entirely upholstered in leather or fabric / Completamente revestidos de piel o tela

## ÉLÉMENTS INDÉPENDANTS / INDEPENDENT ELEMENTS / ELEMENTOS INDEPENDIENTES\* 4/4

**S33** BANQUETTE 2 PLACES INDEP.  
INDEP. 2-SEAT ARMLESS SOFA  
BANQUETA 2 PLAZAS INDEP.

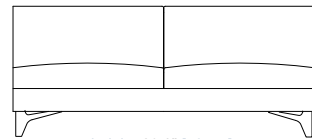
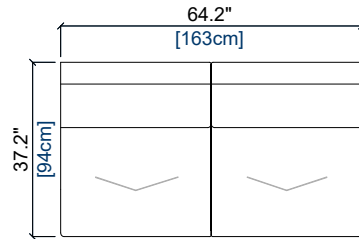

height: 29.8" [76 cm]  
seat height: 16.1" [41 cm]

**S34** BANQUETTE 2 PLACES INDEP. GAUCHE  
INDEP. 2-SEAT ARMLESS SOFA LEFT  
BANQUETA 2 PLAZAS IZQ. INDEP.

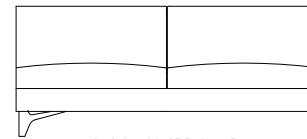
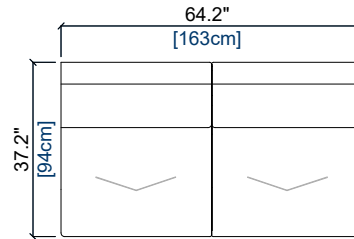

height: 29.8" [76 cm]  
seat height: 16.1" [41 cm]

**S35** BANQUETTE 2 PLACES INDEP. DROITE  
INDEP. 2-SEAT ARMLESS SOFA RIGHT  
BANQUETA 2 PLAZAS DER. INDEP.

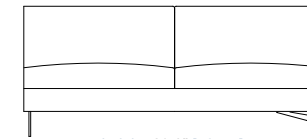
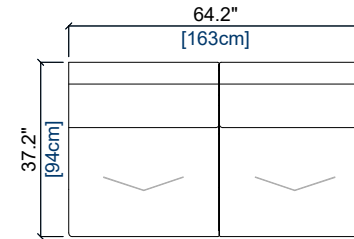

height: 29.8" [76 cm]  
seat height: 16.1" [41 cm]

**S01** CHAUFFEUSE INDEP.  
INDEP. ARMLESS CHAIR  
CHAUFFEUSE INDEP.

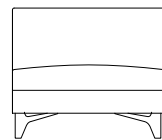
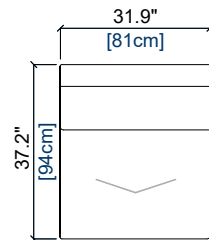

height: 29.8" [76 cm]  
seat height: 16.1" [41 cm]

**S1S** CHAUFFEUSE INDEP. - GAUCHE  
INDEP. ARMLESS CHAIR - LEFT  
CHAUFFEUSE INDEP. - IZQ.

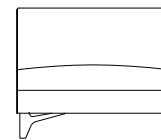
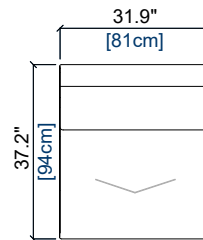

height: 29.8" [76 cm]  
seat height: 16.1" [41 cm]

**S1D** CHAUFFEUSE INDEP. - DROITE  
INDEP. ARMLESS CHAIR - RIGHT  
CHAUFFEUSE INDEP. - DER.

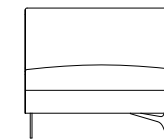
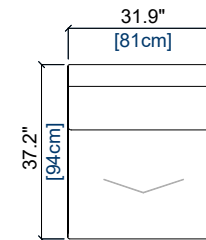

height: 29.8" [76 cm]  
seat height: 16.1" [41 cm]

\* Entièrement habillés de cuir ou de tissu / Entirely upholstered in leather or fabric / Completamente revestidos de piel o tela