

SATELLITE 3

design Sacha LAKIC

rochebobois
PARIS



SATELLITE 3

design Sacha LAKIC

rochebobois
PARIS



SATELLITE 3

rochebobois
PARIS

design Sacha LAKIC



FICHE TECHNIQUE / TECHNICAL SPECIFICATIONS / FICHA TECNICA:

Structure : Sapin massif et multiplis de pin
Suspension : Sangles élastiques HR
Garnissage assise : Mousse polyuréthane HR bi-densité 40-45 kg/m³
Garnissage dossier : Mousse polyuréthane HR densité 25 kg/m³
Couette capitonnée : Fibre polyester
Piétement : Aluminium

Structure: Solid fir wood and pine plywood
Suspension: HR elastic straps
Seat cushion: HR bi-density polyurethane foam 40-45 kg/m³
Back cushion: HR polyurethane foam 25 kg/m³
Padded duvet: Polyester fibre
Legs: Aluminium

Estructura: Abeto macizo y multilaminado de pino
Suspensión: Cinchas elásticas HR
Interior asiento: Espuma poliuretano HR bi-densidad 40-45 kg/m³
Interior respaldo: Espuma poliuretano HR densidad 25 kg/m³
Colchoneta capitonée: Fibra poliéster
Patas: Aluminio

OBSERVATIONS / OBSERVATIONS / OBSERVACIONES:

- Fabrication Européenne
- Accoudoirs et couette d'assise et de dossier capitonnés
- Modèle réalisable en cuir et dans l'ensemble des tissus de la collection Roche Bobois, à l'exception des tissus Techno 2D, Techno 3D, Techno 4D, à motifs ou à rayures (avec raccords), des velours et des microfibres
- Manufactured in Europe
- Armrests, seat and back duvet are padded
- This model is available in leather and all fabrics from the Roche Bobois collection, with the exception of Techno 2D, Techno 3D and Techno 4D fabrics, striped and patterned fabrics (with repeat), velvets and microfibres
- Fabricación europea
- Apoyabrazos y colchoneta de asiento y de respaldo capitonés
- Modelo realizable en piel y en todas las telas de la colección Roche Bobois, excepto con las telas Techno 2D, Techno 3D, Techno 4D, las telas con motivos y rayadas (con racords), los terciopelos y las microfibras

OPTIONS / OPTIONAL / OPCIONES:

- Coutures anglaises ton sur ton ou contrastées, fil épais. Disponibles uniquement dans la version cuir
- Disponible en 2 versions :
 - "Full Relax" avec mécanisme multipositions, module de commande digitale ROCHE BOBOIS amovible encastré dans l'accoudoir
 - Appuie-tête relevable avec mécanisme manuel
- Batterie lithium auxiliaire
- Piétement disponible dans 2 finitions : aluminium Brillant ou aluminium Nickel Noir. Voir page 4
- Tone-on-tone or contrasting English stitching, thick thread. Only available for the leather version
- Available in 2 versions :
 - "Full Relax" with multi-position mechanism, removable ROCHE BOBOIS digital command set in the armrest
 - Adjustable headrest with manual mechanism
- Optional lithium battery
- Legs available in 2 finishes: Glossy Aluminium or Black Nickel aluminium. See page 4
- Costuras inglesas tono sobre tono o contrastadas, hilo grueso. Disponibles solamente para la version en piel
- Disponible en 2 versiones:
 - "Full Relax" con mecanismo multiposición, módulo con mando digital ROCHE BOBOIS extraíble enclavado en el apoyabrazos
 - Cabezal elevable con mecanismo manual
- Bateria de litio auxiliar
- Patas disponibles en 2 acabados: aluminio Brillante o aluminio Níquel Negro. Ver página 4

SATELLITE 3

design Sacha LAKIC

FINITIONS PIETEMENT / LEG FINISH / ACABADO PATAS



Aluminium Brillant
Glossy Aluminium
Aluminio Brillante



Aluminium Nickel Noir
Black Nickel Aluminium
Aluminio Niquel Negro

SATELLITE 3

design Sacha LAKIC

COUTURES ADDITIONNELLES / ADDITIONAL STITCHING / COSTURAS ADICIONALES

Dans le cas d'un revêtement en tissu, des coutures additionnelles seront nécessaires (voir lignes rouges sur le dessin ci-dessous).

In case of fabric upholstery, additional stitching will be needed (see red marks on the drawing below).

En caso de revestimiento en tela, se necesitarán algunas costuras adicionales (ver líneas rojas en el dibujo aquí abajo).

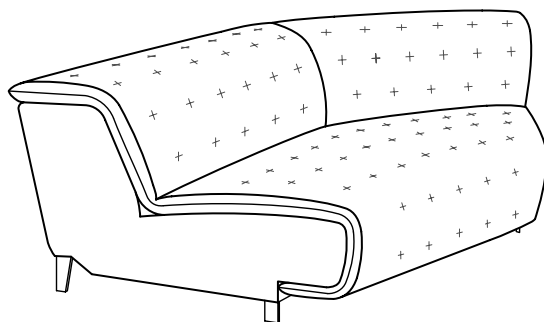

Elément 51 habillé de cuir
Element 51 upholstered in leather
Elemento 51 revestido en piel

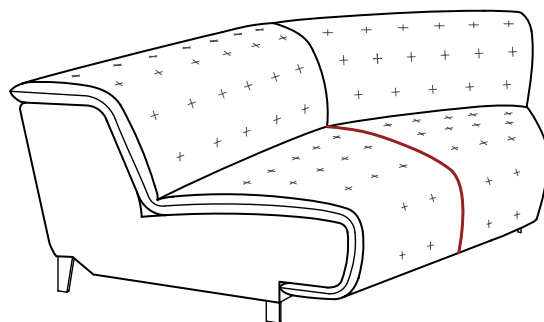

Elément 51 habillé de tissu
Element 51 upholstered in fabric
Elemento 51 revestido en tela

SATELLITE 3

design Sacha LAKIC

DIMENSIONS COMMUNES A TOUS LES ELEMENTS / SAME DIMENSIONS FOR ALL ELEMENTS / MEDIDAS COMUNES A TODOS LOS ELEMENTOS

Les dimensions reportées (profondeur et hauteur de l'élément, profondeur et hauteur de l'assise, largeur des accoudoirs) sont communes à tous les éléments.

The dimensions below (depth and height of the element, depth and height of the seat cushion, width of the armrests) are the same for all elements.

Las medidas mencionadas (profundidad y altura del elemento, profundidad y altura del asiento, ancho de los apoyabrazos), son comunes a todos los elementos.

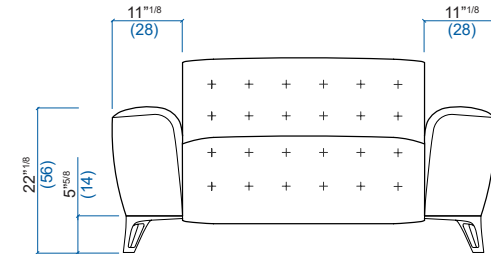

POSITION FERMEE
CLOSED POSITION
POSICION CERRADA

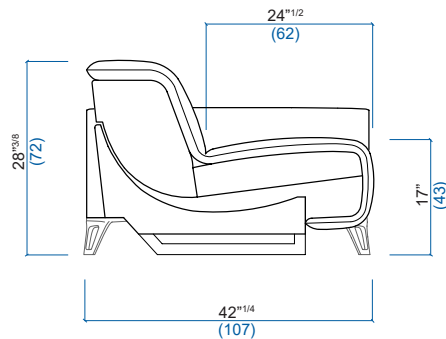

APPUIE-TETE RELEVÉ
RAISED HEADREST
CABEZAL ELEVADO

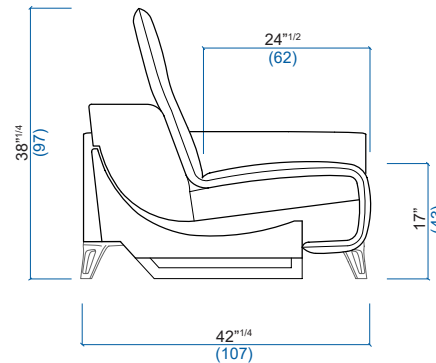

POSITION FULL-RELAX
FULL RELAX POSITION
POSICION FULL-RELAX

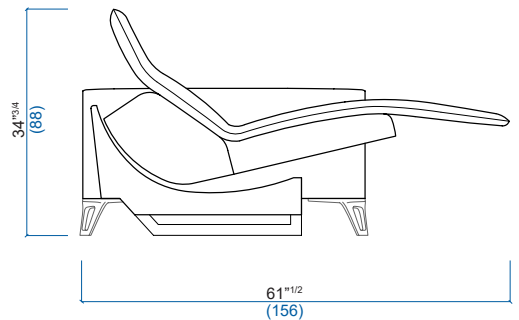

SATELLITE 3

design Sacha LAKIC

FULL RELAX / FULL RELAX / FULL RELAX 1/2

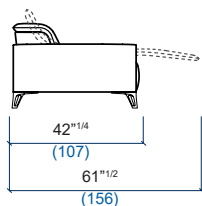

Tout élément central et angle panoramique sera nécessairement relié à 2 bâtards, un de chaque côté de l'élément

Any central element or panoramic corner-unit must be attached to a 1-arm unit on both sides

Todo elemento central y ángulo panorámico tiene que estar unido a 2 batards, uno a cada lado del elemento

08 Petit fauteuil
Small armchair
Pequeño sillón

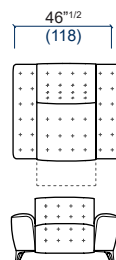

09 Fauteuil
Armchair
Sillón

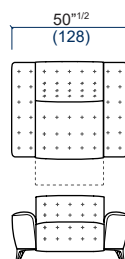

10 Grand Fauteuil
Large armchair
Gran Sillón

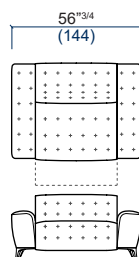

20 Canapé 2.5 places (éléments 12+13)
2.5-seat sofa (elements 12+13)
Sofá 2.5 plazas (elementos 12+13)

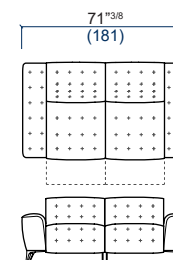

25 Canapé 3 places (éléments 15+16)
3-seat sofa (elements 15+16)
Sofá 3 plazas (elementos 15+16)

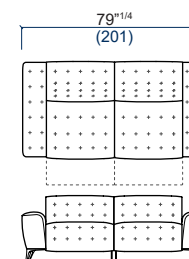

30 Grand canapé 3 places (éléments 17+18)
Large 3-seat sofa (elements 17+18)
Gran sofá 3 plazas (elementos 17+18)

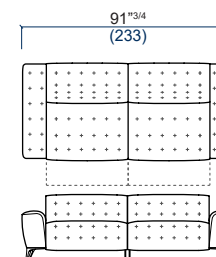

SATELLITE 3

design Sacha LAKIC

FULL RELAX / FULL RELAX / FULL RELAX 2/2

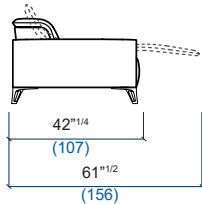

- 13** Bâtard 1 place accoudoir gauche
1-seat 1-arm unit left armrest
Batard 1 plaza apoyabrazo izquierdo

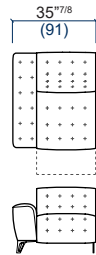

- 12** Bâtard 1 place accoudoir droit
1-seat 1-arm unit right armrest
Batard 1 plaza apoyabrazo derecho

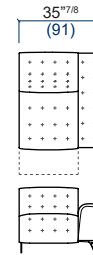

- 11** Elément central
Central element
Elemento central

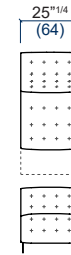

- 15** Bâtard 1 place accoudoir gauche
1-seat 1-arm unit left armrest
Batard 1 plaza apoyabrazo izquierdo

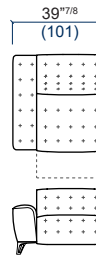

- 16** Bâtard 1 place accoudoir droit
1-seat 1-arm unit right armrest
Batard 1 plaza apoyabrazo derecho

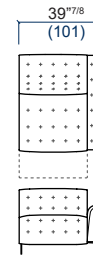

- 14** Elément central
Central element
Elemento central

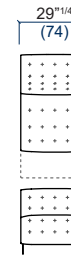

- 17** Bâtard 1 place accoudoir gauche
1-seat 1-arm unit left armrest
Batard 1 plaza apoyabrazo izquierdo

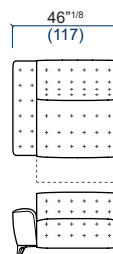

- 18** Bâtard 1 place accoudoir droit
1-seat 1-arm unit right armrest
Batard 1 plaza apoyabrazo derecho

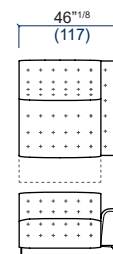

- 19** Elément central
Central element
Elemento central

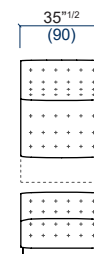

Tout élément central et angle panoramique sera nécessairement relié à 2 bâtards, un de chaque côté de l'élément

Any central element or panoramic corner-unit must be attached to a 1-arm unit on both sides

Todo elemento central y ángulo panorámico tiene que estar unido a 2 batards, uno a cada lado del elemento

SATELLITE 3

design Sacha LAKIC

APPUIE-TETE RELEVABLE / ADJUSTABLE HEADREST / CABEZAL ELEVABLE 1/2



08 Petit fauteuil
Small armchair
Pequeño sillón

46^{1/2}
(118)

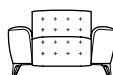
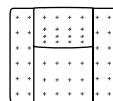

09 Fauteuil
Armchair
Sillón

50^{1/2}
(128)

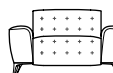
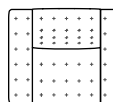

10 Grand Fauteuil
Large armchair
Gran Sillón

56^{3/4}
(144)

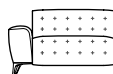
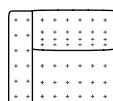

20 Canapé 2.5 places
2.5-seat sofa
Sofá 2.5 plazas

71^{3/8}
(181)

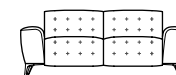
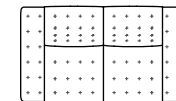

25 Canapé 3 places
3-seat sofa
Sofá 3 plazas

79^{1/4}
(201)

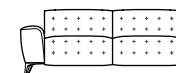
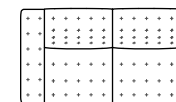

30 Grand canapé 3 places
Large 3-seat sofa
Gran sofá 3 plazas

91^{3/4}
(233)

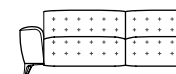
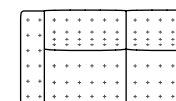

Tout élément central et angle panoramique sera nécessairement relié à 2 bâtarde, un de chaque côté de l'élément

Any central element or panoramic corner-unit must be attached to a 1-arm unit on both sides

Todo elemento central y ángulo panorámico tiene que estar unido a 2 batards, uno a cada lado del elemento

SATELLITE 3

design Sacha LAKIC

APPUIE-TETE RELEVABLE / ADJUSTABLE HEADREST / CABEZAL ELEVABLE 2/2



- 13** Bâtard 1 place accoudoir gauche
1-seat 1-arm unit left armrest
Batard 1 plaza apoyabrazo izquierdo

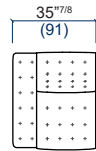

- 12** Bâtard 1 place accoudoir droit
1-seat 1-arm unit right armrest
Batard 1 plaza apoyabrazo derecho

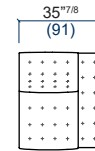

- 11** Elément central
Central element
Elemento central



- 15** Bâtard 1 place accoudoir gauche
1-seat 1-arm unit left armrest
Batard 1 plaza apoyabrazo izquierdo

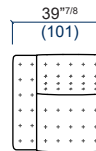

- 16** Bâtard 1 place accoudoir droit
1-seat 1-arm unit right armrest
Batard 1 plaza apoyabrazo derecho

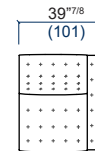

- 14** Elément central
Central element
Elemento central



- 17** Bâtard 1 place accoudoir gauche
1-seat 1-arm unit left armrest
Batard 1 plaza apoyabrazo izquierdo

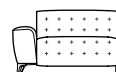
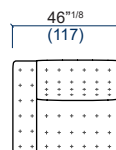

- 18** Bâtard 1 place accoudoir droit
1-seat 1-arm unit right armrest
Batard 1 plaza apoyabrazo derecho

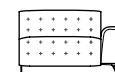
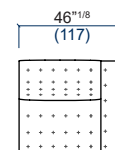

- 19** Elément central
Central element
Elemento central

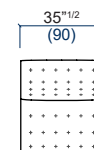

Tout élément central et angle panoramique sera nécessairement relié à 2 bâtards, un de chaque côté de l'élément

Any central element or panoramic corner-unit must be attached to a 1-arm unit on both sides

Todo elemento central y ángulo panorámico tiene que estar unido a 2 batards, uno a cada lado del elemento

SATELLITE 3

design Sacha LAKIC

50 Angle carré
Square corner
Angulo cuadrado

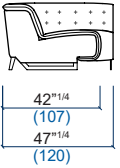
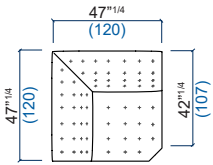

51 Grand angle panoramique
Large panoramic corner-unit
Gran ángulo panorámico

