

SCENARIO 2

design Sacha LAKIC

rochebobo
PARIS



SCENARIO 2

design Sacha LAKIC

rochebobois
PARIS

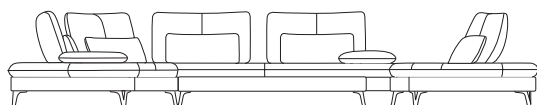
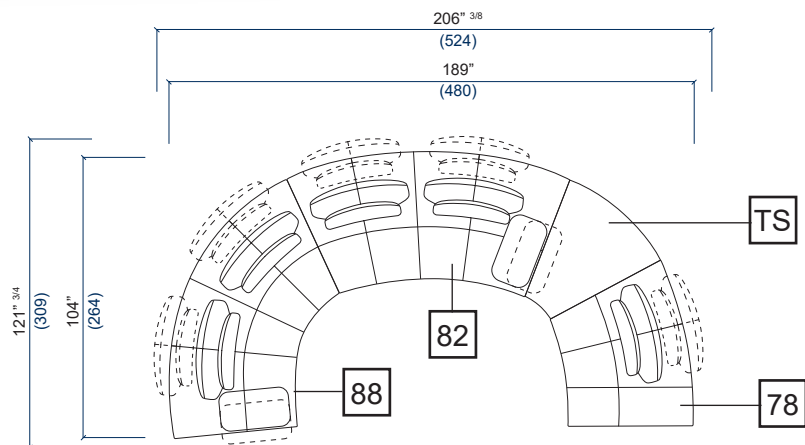

88 Bâtard arrondi grand angle 4 places gauche
Wide angle 4-seat 1-arm rounded unit left armrest
Bâtard redondeado gran ángulo 4 plazas izquierdo

82 Bâtard arrondi 4 places droit
4-seat 1-arm rounded unit right armrest
Bâtard redondeado 4 plazas derecho

TS Table suspendue
Suspended table
Mesa suspendida

78 Terminal arrondi droit
Rounded end unit - Right
Terminal redondeada derecha

SCENARIO 2

design Sacha LAKIC

rochebobois
PARIS



SCENARIO 2

design Sacha LAKIC

rochebobois
PARIS

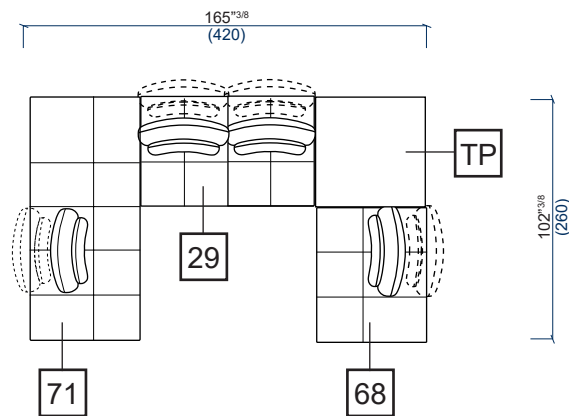

71 Grand Terminal d'angle gauche
Large End corner-unit - Left
Gran Terminal angulo izquierda

TP Table carrée
Square table
Mesa cuadrada

29 Banquette 2.5 places
2.5-seat armless sofa
Banqueta 2.5 plazas

68 Terminal droit
End unit - Right
Terminal derecha

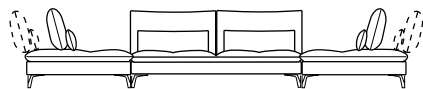

SCENARIO 2

design Sacha LAKIC

rochebobois
PARIS



FICHE TECHNIQUE / TECHNICAL SPECIFICATIONS / FICHA TECNICA:

Structure : Sapin massif, multiplis de pin, panneaux de particules (CARB)
Suspension : Sangles élastiques
Garnissage assise : Mousse polyuréthane bi-densité 35-40 kg/m³ et fibre polyester
Garnissage dossier : Mousse polyuréthane densité 21 kg/m³ et fibre polyester
Garnissage accoudoir : Mousse polyuréthane densité 30 kg/m³ et ouate de polyester
Garnissage cale-reins : Mousse polyuréthane densité 22 kg/m³ et ouate de polyester
Tables : Panneau de fibres de densité moyenne plaqué chêne
Piétement : Fonte d'aluminium

Structure: Solid fir wood, pine plywood, engineered composite wood (CARB)
Suspension: Elastic straps
Seat cushion: Bi-density polyurethane foam 35-40 kg/m³ and polyester fibre
Back cushion: Polyurethane foam 21 kg/m³ and polyester fibre
Armrest cushion: Polyurethane foam 30 kg/m³ and polyester batting
Lumbar cushion: Polyurethane foam 22 kg/m³ and polyester batting
Tables: Medium-density fibreboard with oak veneer
Legs: Cast aluminium

Estructura: Abeto macizo, multilaminado de pino, paneles de partículas (CARB)
Suspensión: Cinchas elásticas
Interior asiento: Espuma poliuretano bi-densidad 35-40 kg/m³ y fibra de poliéster
Interior respaldo: Espuma poliuretano densidad 21 kg/m³ y fibra de poliéster
Interior apoyabrazo: Espuma poliuretano densidad 30 kg/m³ y guata de poliéster
Interior riñonera: Espuma poliuretano densidad 22 kg/m³ y guata de poliéster
Mesas: Paneles de fibras de densidad media chapado roble
Patas: Fundición de aluminio

OBSERVATIONS / OBSERVATIONS / OBSERVACIONES:

- Fabrication Européenne
- Dossiers à double profondeur avec mécanisme à balancier. Profondeur avec dossier ouvert : +22cm
- Accoudoirs mécaniques avec ouverture latérale. Largeur de chaque accoudoir ouvert : +23cm
- Assise capitonnée
- Cale-reins intégrés aux coussins de dossier
- Le dossier de l'Angle carré est fixe
- Modèle réalisable en cuir et dans l'ensemble des tissus de la collection Roche Bobois, à l'exception des tissus Techno 2D-3D-4D, Marshmallow Uni, Orsetto Flex, Chroma, Câlin et Douceur, des tissus à motifs ou à rayures (avec raccords), des velours et des microfibres

- Manufactured in Europe
- Back cushions with double depth by manual mechanism. When opened, the depth is +22cm
- Manually adjustable armrests with side partition. When opened, each armrest is +23cm
- Padded seat cushions
- Lumbar cushions attached to the backs
- The backrest of the Square corner is fixed
- This model is available in leather and all fabrics from the Roche Bobois collection, with the exception of Techno 2D-3D-4D, Marshmallow Uni, Orsetto Flex, Chroma, Câlin and Douceur fabrics, and striped or patterned fabrics (with repeat), velvets and microfibres

- Fabricación europea
- Respaldos de doble profundidad con mecanismo a balancín. Profundidad con respaldo abierto: +22cm
- Apoyabrazos mecánicos con apertura lateral. Ancho de cada apoyabrazos abierto: +23cm
- Cojín de asiento capitoné
- Riñoneras integradas en los cojines del respaldo
- El respaldo del Angulo cuadrado es fijo
- Modelo realizable en piel y en todas las telas de la colección Roche Bobois, excepto con las telas Techno 2D-3D-4D, Marshmallow Uni, Orsetto Flex, Chroma, Câlin y Douceur las telas con motivos o rayadas (con raccords), los terciopelos y las microfibras

OPTIONS / OPTIONAL / OPCIONES:

- Coutures anglaises blanches, contrastées ou ton sur ton, fil épais, disponibles uniquement dans la version cuir
- Dossier disponible en 2 hauteurs : standard et grande hauteur (+ 5cm, en option). Voir page 8
- Piétement disponible dans 2 finitions : Chromé Brillant ou Nickel Noir. Voir page 6
- Tables disponibles dans 5 finitions : Gris, Sable, Souris, Taupe et Wengé. Voir page 7

- White, contrasting or tone-on-tone english stitching; thick thread, only available for leather version
- Backrest available in 2 heights: standard and high (+ 5cm, optional). See page 8
- Legs available in 2 finishes: Glossy Chrome-plated or Black Nickel. See page 6
- Tables available in 5 finishing: Grey, Sable, Souris, Taupe and Wenge. See page 7

- Costuras inglesas blancas, tono sobre tono o contrastadas, hilo grueso, disponibles solamente para la versión en piel
- Respaldo disponible en 2 alturas: estándar y alto (+5cm, opcional). Ver página 8
- Patas disponibles en 2 acabados: Cromado Brillante o Barnizado Níquel Negro. Ver página 6
- Mesas disponibles en 5 acabados: Gris, Sable, Souris, Taupe y Wengé. Ver página 7

SCENARIO 2

design Sacha LAKIC

rochebobois
PARIS

FINITIONS PIETEMENT / LEG FINISH / ACABADO PATAS



Chromé Brillant
Glossy Chrome-plated
Cromado Brillante



Nickel Noir
Black Nickel
Niquel Negro

SCENARIO 2

design Sacha LAKIC

rochebobo
PARIS

FINITIONS TABLES / TABLES FINISH / ACABADO MESAS



Teinte Gris
Grey stain
Tinte Gris



Teinte Sable
Sable stain
Tinte Sable



Teinte Souris
Souris stain
Tinte Souris



Teinte Taupe
Taupe stain
Tinte Taupe



Teinte Wengé
Wenge stain
Tinte Wengé



SCENARIO 2

design Sacha LAKIC

DIMENSIONS COMMUNES A TOUS LES ELEMENTS / SAME DIMENSIONS FOR ALL ELEMENTS / MEDIDAS COMUNES A TODOS LOS ELEMENTOS

Les dimensions reportées (profondeur et hauteur de l'élément, profondeur et hauteur de l'assise, largeur des accoudoirs) sont communes à tous les éléments.

The dimensions below (depth and height of the element, depth and height of the seat cushion, width of the armrests) are the same for all elements.

Las medidas mencionadas (profundidad y altura del elemento, profundidad y altura del asiento, ancho de los apoyabrazos), son comunes a todos los elementos.

Hauteur standard
Standard height
Altura estándar

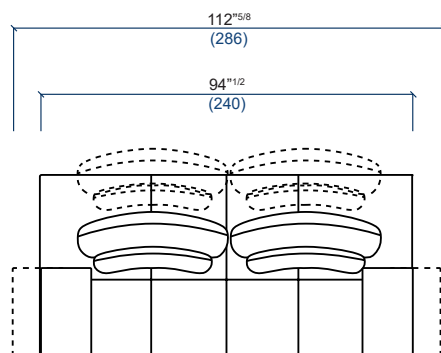

OPTION / OPTIONAL / OPCIONE
Hauteur +5cm
Height +5cm
Altura +5cm

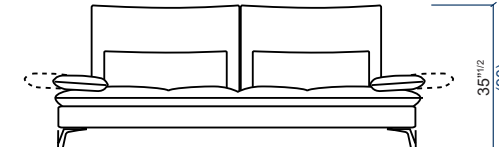
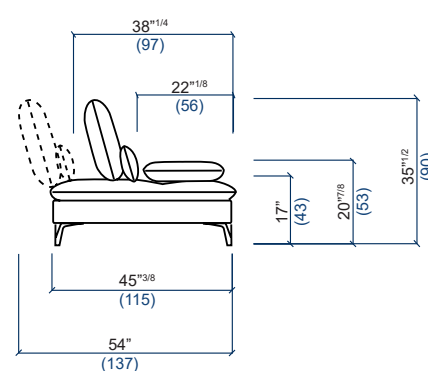
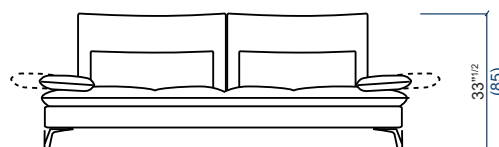
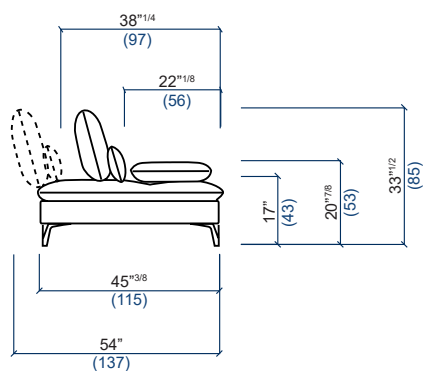
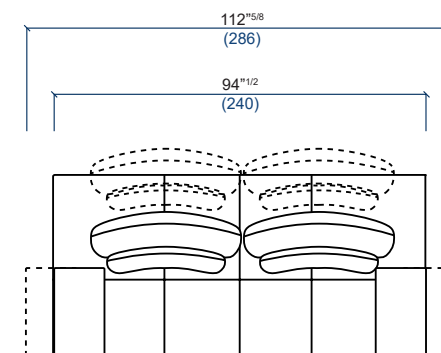

SCENARIO 2

design Sacha LAKIC

rochebobois
PARIS

COMPOSITION CARRÉE OU ARRONDIE : COMPARAISON DE L'ENCOMBREMENT
SQUARE OR ROUNDED COMPOSITION: SIZE COMPARISON
COMPOSICIÓN CUADRADA O REDONDEADA: COMPARACIÓN DEL TAMAÑO

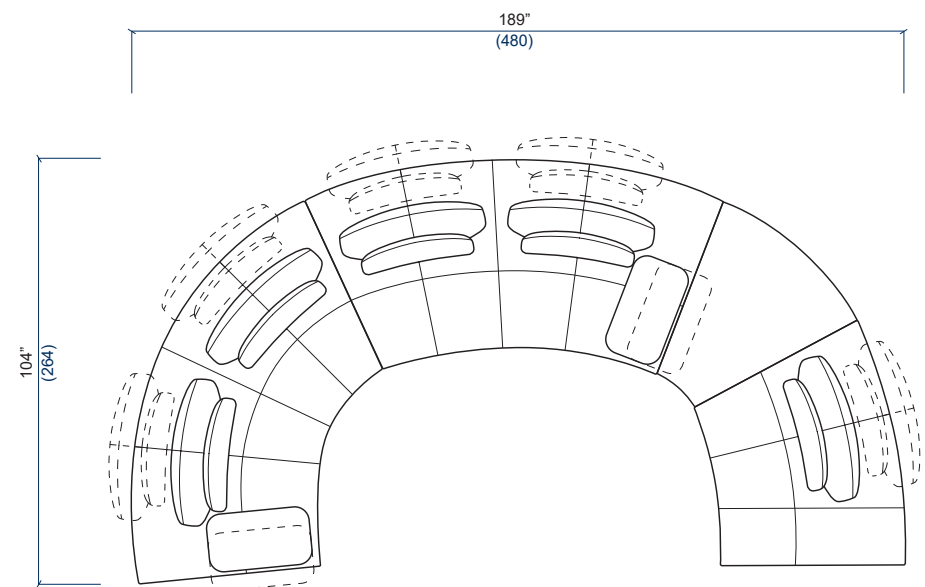
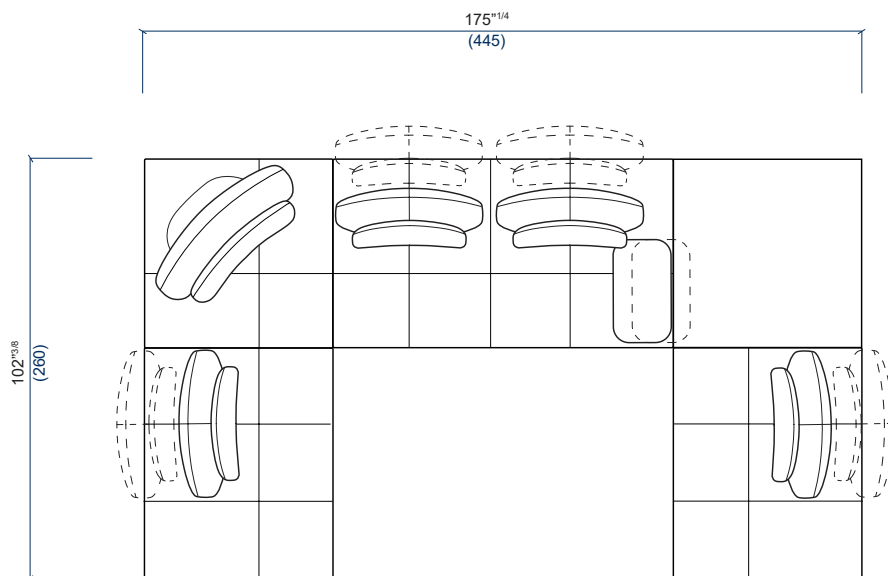

SCENARIO 2

design Sacha LAKIC

rochebobois
PARIS

30 Canapé 3 places
3 seater sofa
Sofá 3 plazas

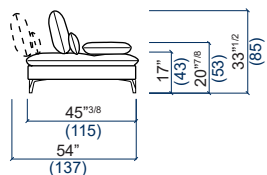
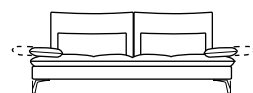
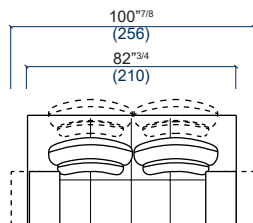

35 Grand Canapé 3 places
Large 3 seater sofa
Gran Sofá 3 plazas

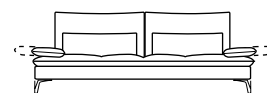
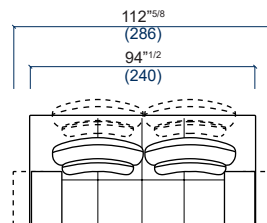

36 Grand Canapé 4 places
Large 4 seater sofa
Gran Sofá 4 plazas

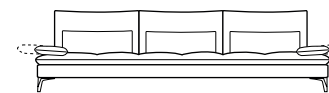
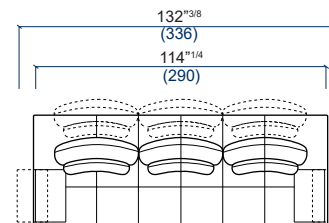

13 Bâtard 1 place gauche
1-seat 1-arm unit left armrest
Batard 1 plaza izquierdo

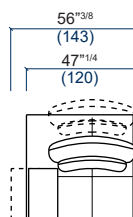

12 Bâtard 1 place droit
1-seat 1-arm unit right armrest
Batard 1 plaza derecho

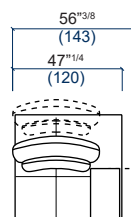

38 Bâtard 3 places gauche
3-seat 1-arm unit left armrest
Batard 3 plazas izquierdo

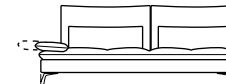
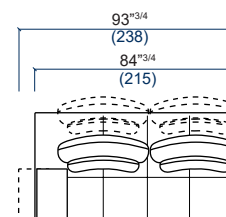

37 Bâtard 3 places droit
3-seat 1-arm unit right armrest
Batard 3 plazas derecho

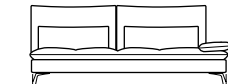
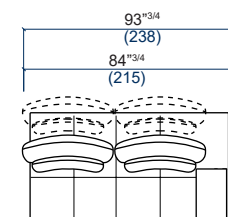

SCENARIO 2

design Sacha LAKIC

rochebobois
PARIS

14 Chauffeuse
Armless chair
Chauffeuse

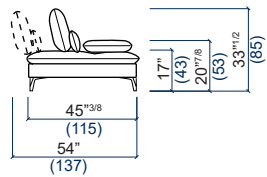
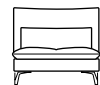
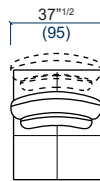

29 Banquette 2.5 places
2.5-seat armless sofa
Banqueta 2.5 plazas

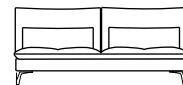
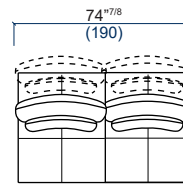

67 Terminal gauche
End unit - Left
Terminal izquierda

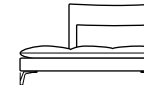
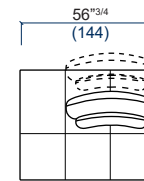

68 Terminal droit
End unit - Right
Terminal derecha

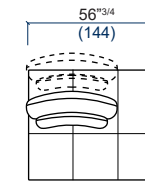

54 Chaise longue
Lounge chair
Chaise longue

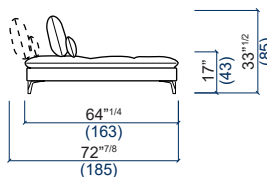
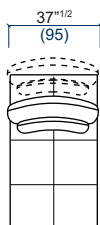

71 Grand Terminal d'angle gauche
Large End corner-unit - Left
Gran Terminal angulo izquierda

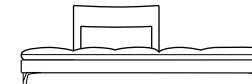
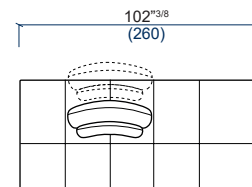

70 Grand Terminal d'angle droit
Large End corner-unit - Right
Gran Terminal angulo derecha

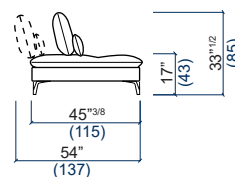
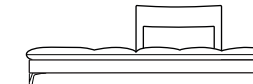
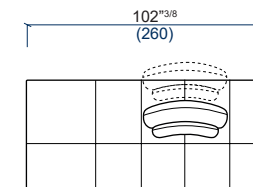

SCENARIO 2

design Sacha LAKIC

rochebobois
PARIS

88 Bâtard arrondi grand angle 4 places gauche
Wide angle 4-seat 1-arm rounded unit left armrest
Batard redondeado gran ángulo 4 plazas izquierdo

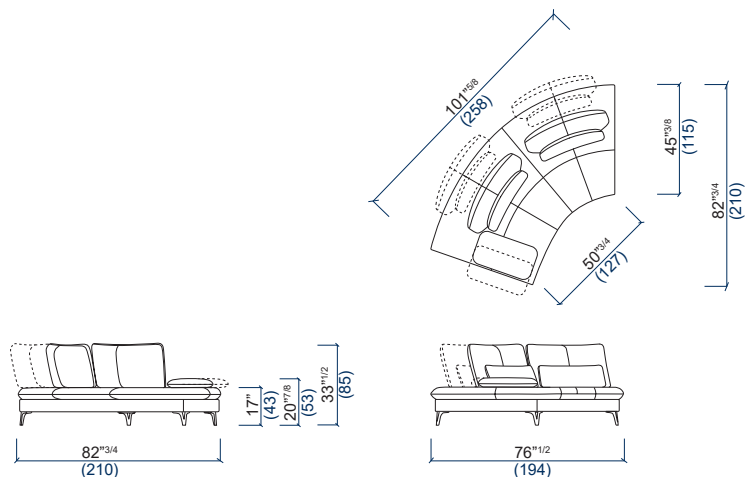

87 Bâtard arrondi grand angle 4 places droit
Wide angle 4-seat 1-arm rounded unit right armrest
Batard redondeado gran ángulo 4 plazas derecho

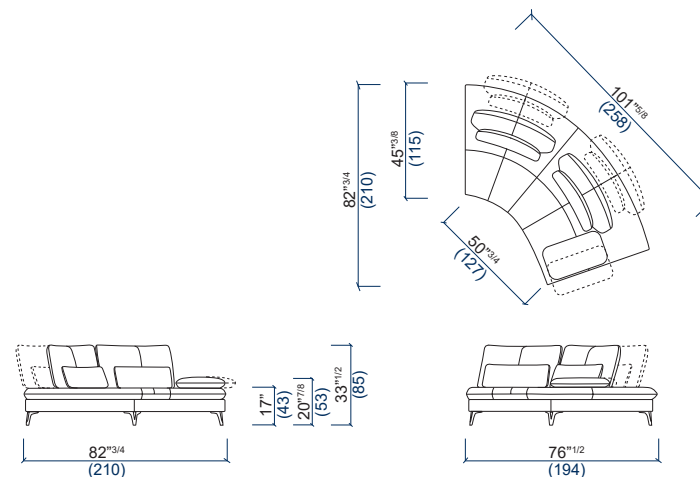

83 Bâtard arrondi 4 places gauche
4-seat 1-arm rounded unit left armrest
Batard redondeado 4 plazas izquierdo

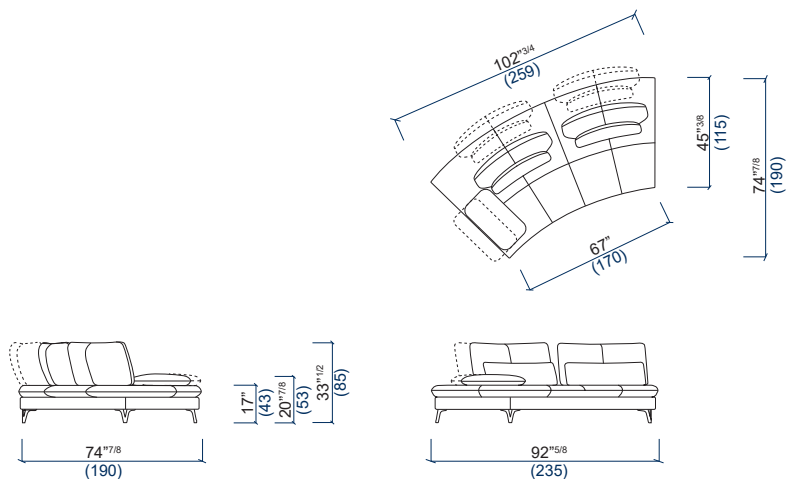

82 Bâtard arrondi 4 places droit
4-seat 1-arm rounded unit right armrest
Batard redondeado 4 plazas derecho

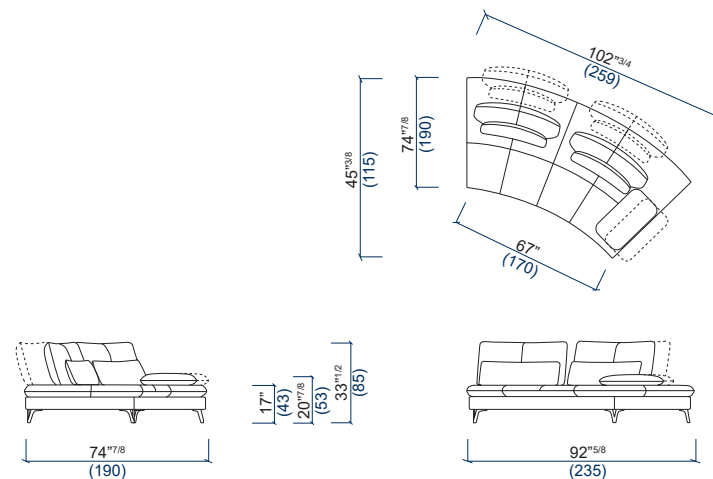

SCENARIO 2

design Sacha LAKIC

rochebobois
PARIS

77 Terminal arrondi gauche
Rounded end unit - Left
Terminal redondeada izquierda

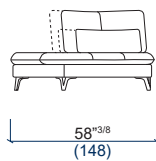
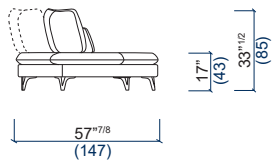
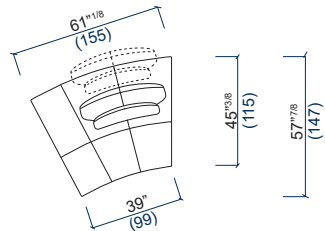

78 Terminal arrondi droit
Rounded end unit - Right
Terminal redondeada derecha

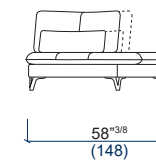
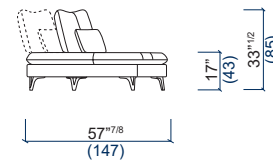
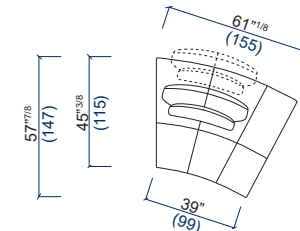

89 Banquette arrondie
Rounded armless sofa
Banqueta redondeada

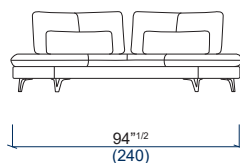
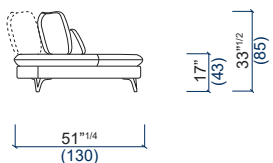
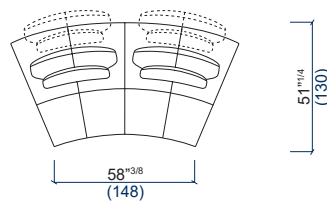

50 Angle carré
Square corner
Ángulo cuadrado

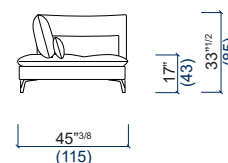
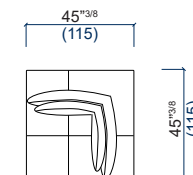

SCENARIO 2

design Sacha LAKIC

rochebobo
PARIS

40 Pouf carré L.115
Square ottoman L.115
Puf cuadrado L.115

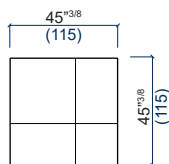

41 Pouf carré L.95
Square ottoman L.95
Puf cuadrado L.95

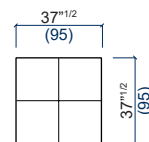

49 Dossier indépendant
Independent backrest
Respaldo independiente

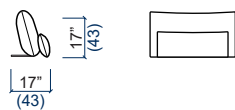
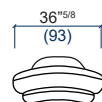

SCENARIO 2

design Sacha LAKIC

rochebobois
PARIS

TP Table carrée
Square table
Mesa cuadrada

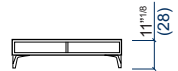
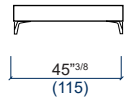
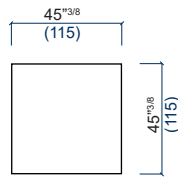

TG Table rectangulaire L.163
Rectangular table L.163
Mesa rectangular L.163

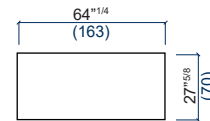

TR Table rectangulaire L.115
Rectangular table L.115
Mesa rectangular L.115

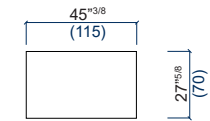

TC Table arrondie
Rounded table
Mesa redondeada

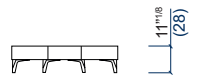
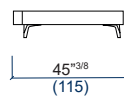
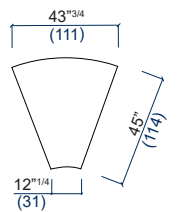

TS Table suspendue
Suspended table
Mesa suspendida

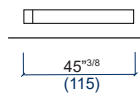
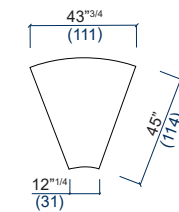

SCENARIO 2

design Sacha LAKIC

rochebobois
PARIS

COMPOSITIONS TYPE / TYPE COMPOSITIONS / COMPOSICIONES TIPO 1/3

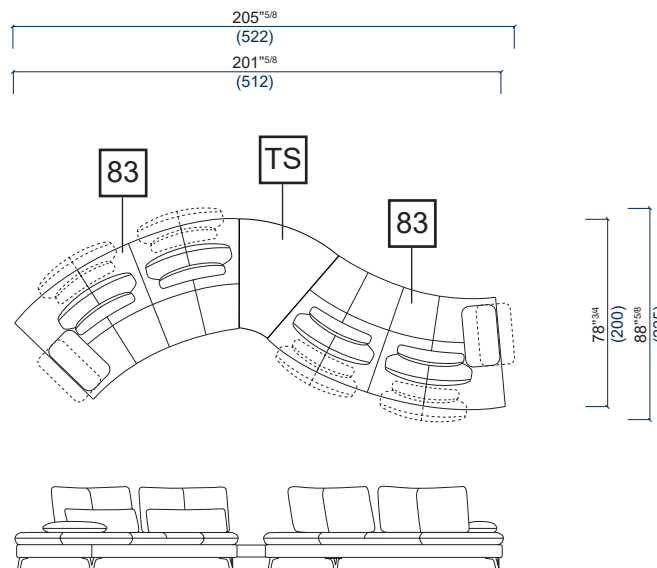
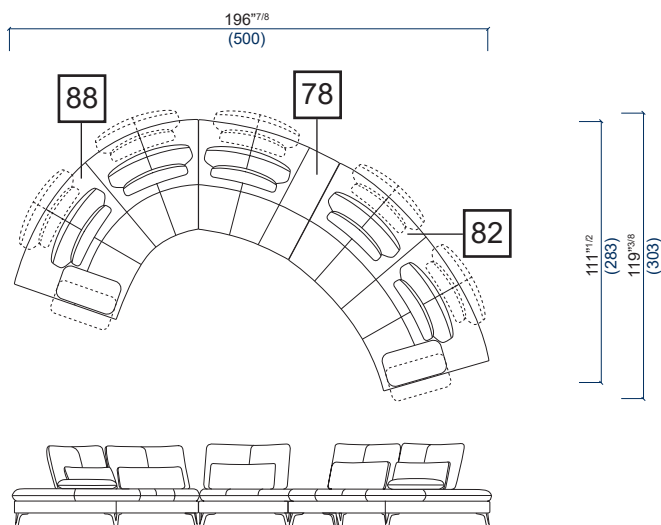
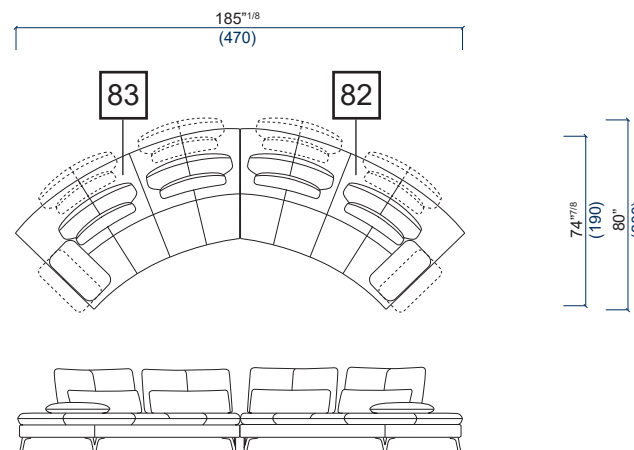
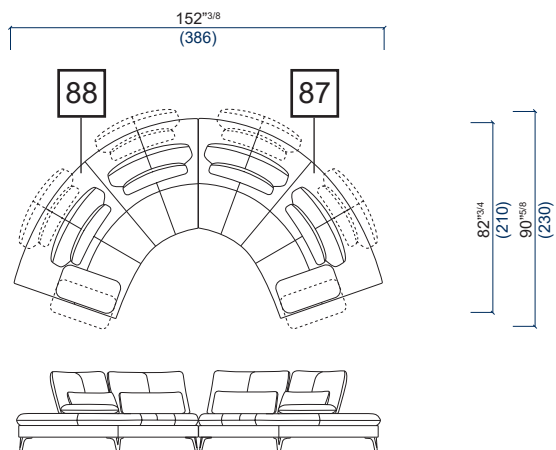

SCENARIO 2

design Sacha LAKIC

rochebobois
PARIS

COMPOSITIONS TYPE / TYPE COMPOSITIONS / COMPOSICIONES TIPO 2/3

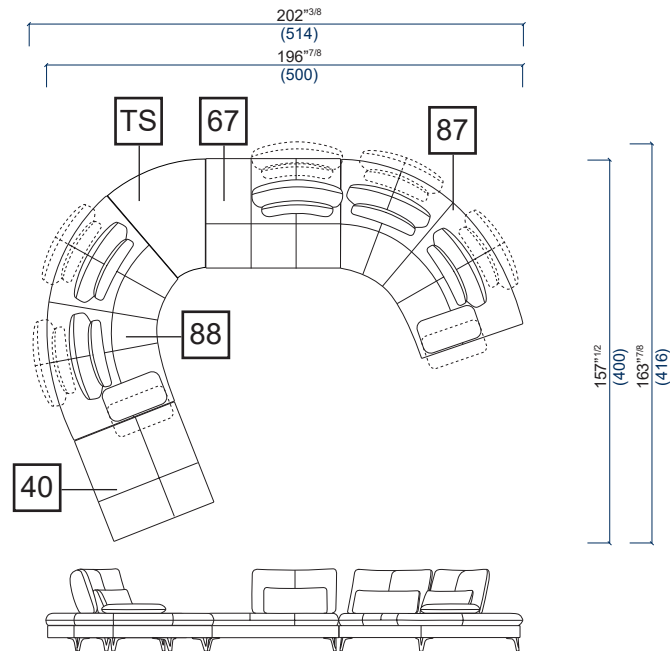
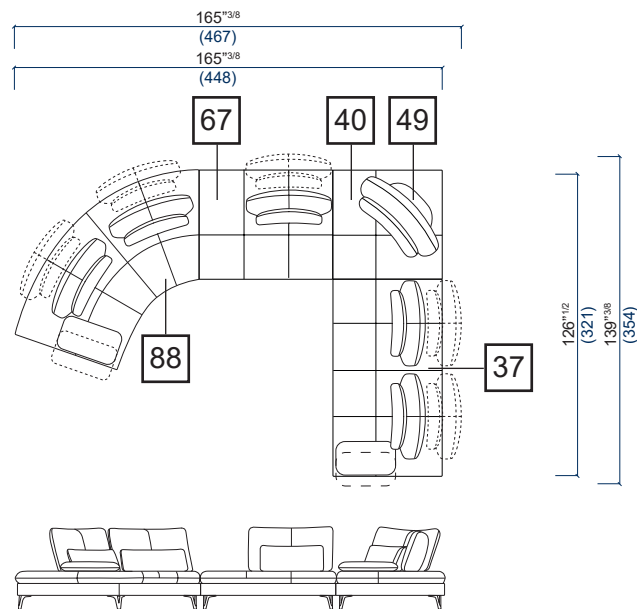
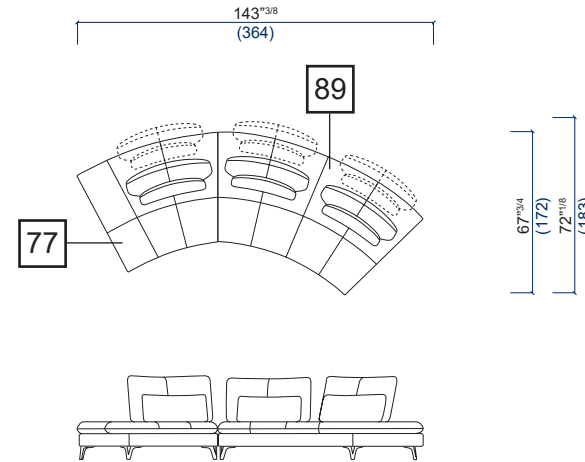
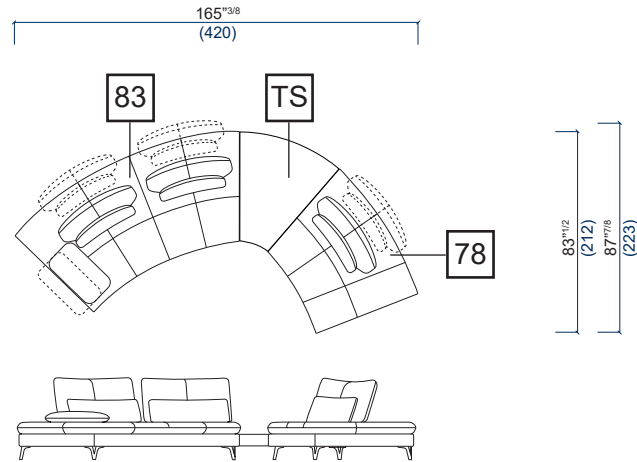

SCENARIO 2

design Sacha LAKIC

rochebobois
PARIS

COMPOSITIONS TYPE / TYPE COMPOSITIONS / COMPOSICIONES TIPO 3/3

